

QSTERPMU PORTABLE PHASOR MEASUREMENT UNIT

QUICK START MANUAL

STER PMU Quick Start Manual rev. 1.1.2425

Studio Elektronike Rijeka d.o.o. [STER]

Radmile Matejčić 10

HR-51000 Rijeka, Croatia

Web: www.wamster.net

E-mail: info@wamster.net



Mark on your equipment certifies that this equipment meets the requirements of the EU (European Union) concerning safety and interference causing equipment regulations

© 2010-2016 STUDIO ELEKTRONIKE RIJEKA

STER PMU and WAMSTER are trademarks of Studio Elektronike Rijeka. No part of this publication may be reproduced or utilized in any form or by any means without a written permission from Studio Elektronike Rijeka.

Visit www.wamster.net for the latest version of this and other applicable manuals. You may need to log in using your account credentials.

Table of contents

1	Introduction	5
1.1	Main Features	5
1.2	Safety considerations.....	5
1.3	Applicable standards.....	6
2	Description	7
2.1	Front panel.....	7
2.2	Connector panel.....	8
2.3	Bottom view.....	9
2.4	Accessories.....	9
2.4.1	Standard accessories.....	9
2.4.2	Optional accessories	10
3	Getting started	11
3.1	Cabling and connecting the device	11
3.1.1	Connecting the power supply and powering on	11
3.1.2	Connecting the GPS receiver.....	11
3.1.3	Cabling setup when using the GPRS modem	12
3.1.4	POsitioning the GPRS Antenna and the GPS receiver	13
3.2	Configuring the device for first use.....	13
3.2.1	Main screen.....	13
3.2.2	Setup menu	14
3.2.3	Communication Setup menu	15
3.2.4	Managing the device using the Wamster web interface	18
3.2.5	Powering off.....	18
4	Working with the instrument.....	19
4.1	General considerations for wiring.....	19
4.1.1	Connecting voltage terminals	19
4.1.2	Connecting current terminals	19
4.2	Changing measurement settings	20
4.2.1	Measurement Setup screen.....	20
4.2.2	Voltage measurement.....	20
4.2.3	Current Measurement	22
4.2.4	Synchronization channel.....	23
4.2.5	System Frequency	23
4.2.6	Frequency calculation	23
4.3	Wiring examples	23
4.3.1	Connecting to Low-Voltage power systems.....	23
4.3.2	Connecting to Mid- and High-Voltage power systems.....	26
4.4	Viewing measurements on the device.....	27
4.4.1	Meter view / Scope	27
4.4.2	Phase diagram.....	28
4.4.3	Harmonics meter	28

- 4.4.4 Harmonics logger 28
- 4.4.5 Events..... 29
- 5 Instrument maintenance31**
- 5.1 Changing batteries 31
- 5.2 Safety considerations..... 31
- 5.3 Batteries..... 32
- 5.4 Power supply considerations 32
- 5.5 Cleaning 32
- 5.6 Periodic calibration 33
- 5.7 Service..... 33
- 5.8 Troubleshooting..... 33
- 6 Using the Wamster web interface35**
- 6.1 Minimal configuration..... 35
- 6.2 Signing in to Wamster..... 35
- 6.3 Overview 36
- 6.3.1 Device Settings form 37
- 6.3.2 General settings 38
- 6.3.3 Local triggering..... 39
- 6.3.4 Rewiring Rules..... 40
- 6.3.5 Scaling/Rotation Settings 40
- 6.3.6 Digital I/O 41
- 6.4 Synchronized comparison 42
- 6.4.1 Switching between real-time and historical views 43
- 6.5 Geographic locations 43
- 6.5.1 Setting the reference device for comparison 44
- 6.5.2 Switching between real-time and historical views 44
- 6.6 Configuring and viewing triggered events 44
- 6.7 Analyzing synchrophasor Trends 46
- 6.7.1 Data settings sidebar..... 47
- 6.7.2 View settings toolbar 47
- 6.7.3 Chart interaction 48
- 6.7.4 Chart annotations 48
- 6.8 Waveforms/Oscillograms..... 49
- 6.9 Harmonics 49
- 6.10 Harmonic trends 50
- 6.11 Exporting and downloading data 50
- 6.12 Remote access 52
- 6.13 Support page..... 53
- 7 Notes.....55**

1 Introduction

STER PMU is a handheld synchrophasor measurement unit, equipped with a rechargeable battery pack, GPS for time source, GPRS modem or Serial to Ethernet converter for remote data reporting, and SD card slot for local storage of 5 months of synchrophasor measurements.

It is designed to provide an easy to setup solution for remote measurement and data acquisition. Combined with the WAMSTER cloud storage system, it provides instant access to measured data through an ad-hoc, zero configuration network.

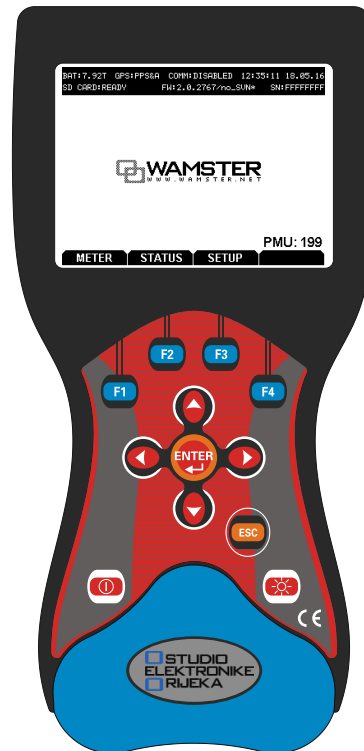

Figure 1.1: Ster PMU device

1.1 MAIN FEATURES

- 4 voltage channels with wide measurement range: 0 ÷ 1000 Vrms, CAT III / 1000 V.
- 4 current channels with support for automatic clamp recognition¹.
- Simultaneous 8 channels - 16bit AD conversion for accurate power measurements (minimal phase shift error).
- Up to 4 hours of autonomous (battery) supply.
- 8Mb of internal flash memory for 77 minutes of synchrophasor data, or 32Gb of external flash memory (SD card) for more than 5 months of synchronous reporting speed measurements
- GPRS modem provided for remote connection to the Wamster server.

1.2 SAFETY CONSIDERATIONS

To ensure operator safety while using the STER PMU instruments and to minimize the risk of damage to the instrument, please note the following general warnings:

¹ with selected Smart clamp types



The instrument is designed to ensure maximum operator safety. Usage in a way other than specified in this manual may increase the risk of harm to the operator!



Do not use the instrument and/or any accessories if there is any damage visible!



The instrument contains no user serviceable parts. Only an authorized dealer can carry out service or adjustment!



All normal safety precautions have to be taken in order to avoid risk of electric shock when working on electrical installations!



Only use approved accessories available from your distributor!



Instrument contains rechargeable NiMh batteries. The batteries should only be replaced with the same type as defined on the battery placement label or in this manual. Do not use standard batteries while power supply adapter/charger is connected, otherwise they may explode!



Hazardous voltages exist inside the instrument. Disconnect all test leads, remove the power supply cable and switch off the instrument before removing battery compartment cover.



In hot (> 40 °C) environments, the battery lid screw might reach the maximum allowed temperature for metal part of handle. In such environment it is advisable not to touch the battery cover during or immediately after the charging.



Maximum voltage between any phase and neutral input is 1000 V_{RMS}. Maximum voltage between phases is 1730 V_{RMS}.



Always short unused voltage inputs (L1, L2, L3, GND) with the neutral (N) input to prevent measurement errors and false event triggering due to noise coupling.

1.3 APPLICABLE STANDARDS

STER PMU device is designed and tested in accordance with the following standards:

Electromagnetic compatibility(EMC)

EN 61326-2-2: 2006

Electrical equipment for measurement, control and laboratory use.

Emission: Class A equipment (for industrial purposes)

Immunity for equipment intended for use in industrial locations

Safety (LVD)

EN 61010-1: 2001

Safety requirements for electrical equipment for measurement, control and laboratory use

Measurement methods

TBD

NOTE ABOUT EN AND IEC STANDARDS:

Text of this manual contains references to European standards. All standards of EN 6XXXX (e.g. EN 61010) series are equivalent to IEC standards with the same number (e.g. IEC 61010) and differ only in amended parts required by European harmonization procedure.

2 Description

2.1 FRONT PANEL

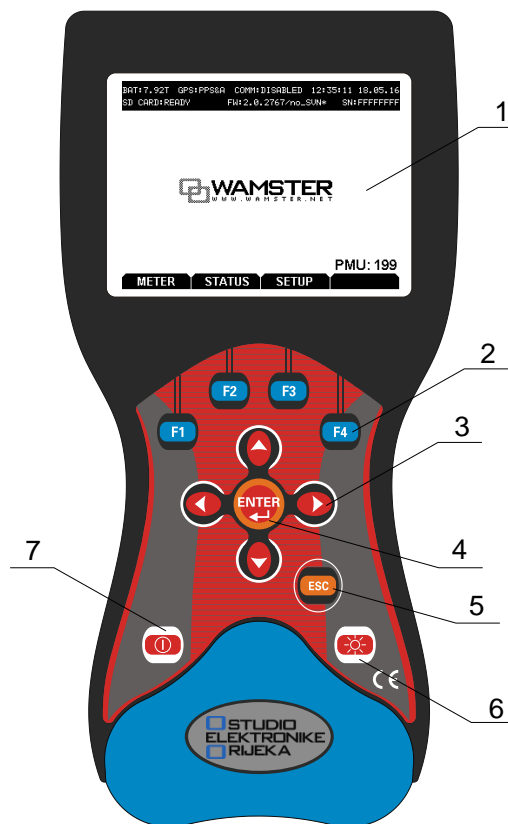
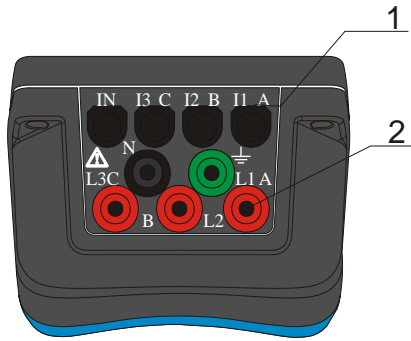

Figure 2.1: Front panel

Front panel layout:

1	LCD	Graphic display with LED backlight, 320 x 200 pixels.
2	F1 – F4	Soft function keys. Their function is indicated for each screen separately, at the bottom of the LCD display.
3	ARROW keys	Move cursor and select parameters.
4	ENTER key	Confirms new settings, step into submenu.
5	ESC key	Exits any procedure, exit from submenu.
6	LIGHT key	LCD backlight on/off (backlight automatically turns off after 15 minutes if no key action occurs).
7	ON-OFF key	Turns on/off the instrument.

2.2 CONNECTOR PANEL



Warning!

Use safety test leads only!

Max. permissible voltage between voltage input terminals and ground is 1000 V_{RMS}.

Max. permissible voltage between voltage input terminals is 1730 V_{RMS}

Figure 2.2: Top connector panel

Top connector panel layout:

1	CURRENT TERMINALS	Clamp-on current transformers (I ₁ , I ₂ , I ₃ , I _N) input terminals.
2	VOLTAGE TERMINALS	Voltage (L ₁ , L ₂ , L ₃ , N, GND) input terminals.

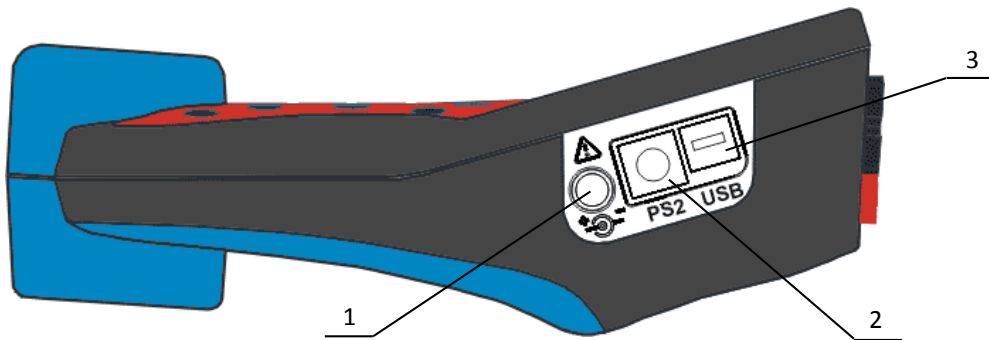

Figure 2.3: Side connector panel

Side connector panel layout:

1	External power socket	12 VDC, 1.2A power supply socket.
2	PS2 type GPS/auxiliary power connector	Composite connector for GPS module input and auxiliary model power supply output. Provided Y-split PS2 cable allows backup battery power supply to be used for external equipment (GPRS/Ethernet modem).
3	USB/serial modem connector	Serial data connector for the GPRS/Ethernet modem.



Use the provided cables and adapters only to avoid damaging the equipment. Although standard PS2 and USB connectors are used, their terminals are arranged to allow additional signals (like modem power supply), and are NOT SUITED for use with PC or similar equipment.

2.3 BOTTOM VIEW

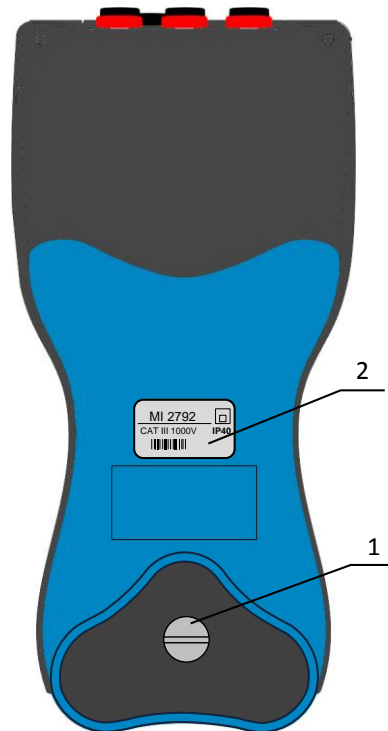

Figure 2.4: Bottom view

Bottom view layout:

- | | | |
|----------|---------------------|--|
| 1 | Battery compartment | To replace the batteries, unscrew the lid screw using a large screwdriver or a coin. Refer to the <i>Instrument</i> maintenance chapter for details. |
| 2 | Serial number label | Device serial number. |



Warning! Refer to the *Instrument* maintenance chapter for details about replacing the batteries. Never replace the batteries while the device is connected to the power supply and measurement leads.

2.4 ACCESSORIES

2.4.1 STANDARD ACCESSORIES

Table 2.1: STER PMU standard accessories

Description	Pcs.
Current transformer 5 A / 1 V (A 1037)	1
Test probe (CAT II), red	3
Test probe (CAT II), black	1
Crocodile clip, red	3
Crocodile clip, black	1
Crocodile clip, green	1
Voltage measurement cable, red	3

Voltage measurement cable, black	1
Voltage measurement cable, green	1
USB to female DB9 cable	1
Male DB9 to male DB9 cable	1
12 V / 1.2 A Power supply adapter for the STER PMU device	1
NiMH rechargeable battery, type HR 6 (AA)	6
Soft carrying bag	1
Instruction manual for STER PMU	1
GPS Receiver	1
Y-split cable with a connector modem power supply	1
Crossover UTP patch cable	1
GPRS Modem ¹	1
SENA PS110 Serial to Ethernet converter ¹	1
Power supply adapter for the SENA PS110 Serial to Ethernet converter ¹	1
SENA PS110 Quick Start Guide CD-ROM	1

2.4.2 OPTIONAL ACCESSORIES

Table 2.2: STER PMU optional accessories

Ord. code	Description	
A 1020	Small soft carrying bag	<p>The image shows various optional accessories for the STER PMU. It includes a blue carrying bag (A 1020), a blue current clamp (A 1033), a blue flexible current clamp (A 1227), a blue connection cable (A 1039), a mini current clamp (A 1069), a mini current clamp (A 1122), a 3-phase flexible current clamp (A 1179), safety fuse adapters (S 2014), safety flat clamps (S 2015), a current clamp (A 1281), and a UMTS (3G) modem (A 1356). There are also several other cables and components shown, including a power supply adapter (A 1037), a Y-split cable (A 1069, A 1122), a crossover UTP patch cable (A 1039), a GPRS Modem (A 1279), and a power supply adapter for the SENA PS110 (A 1355).</p>
A 1033	Current clamp 1000 A / 1 V	
A 1227	Flexible current clamp 3000 A / 300 A / 30 A	
A 1039	Connection cable for current clamp	
A 1069	Mini current clamp 100 A / 1 V	
A 1122	Mini current clamp 5 A / 1 V	
A 1179	3-phase flexible current clamps 2000 A / 200 A / 20 A	
S 2014	Safety fuse adapters	
S 2015	Safety flat clamps	
A 1281	Current clamp 5 A / 100 A / 1000 A	
A 1356	UMTS (3G) modem	

¹ Depends on the actual order specification

3 Getting started

3.1 CABLING AND CONNECTING THE DEVICE

3.1.1 CONNECTING THE POWER SUPPLY AND POWERING ON

STER PMU devices are shipped with batteries partially charged and ready for use. Batteries must be inserted according to procedure described in chapter 5.1 *Changing batteries*. Device can operate on fully charged batteries for up to 4 hours before shutting down. If the device does not power on after pressing the ON-OFF key, batteries may need recharging.

-  Although the device can be immediately powered on by pressing the ON-OFF key, it is recommended to always turn it on by plugging in the power supply.

Connect the charger to the bottom socket at the side panel, as shown on the picture below.

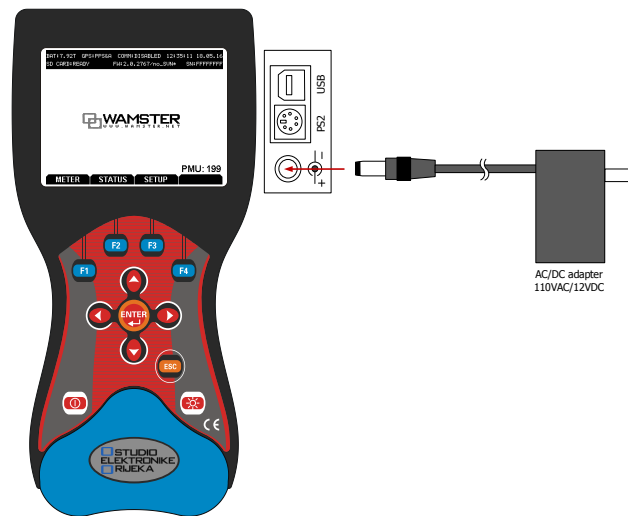

Figure 3.1: Connecting the charger (power supply)

If the device was previously powered off, it will power on automatically as soon as the charger is inserted. ON-OFF key can only turn off the device when the charger is disconnected, to ensure that the device is never accidentally powered off. Pressing the ON-OFF button while the charger is connected will restart the device.

Once powered on, device will start measuring and storing data immediately, storing the measurements to its internal and, optionally, external memory.

3.1.2 CONNECTING THE GPS RECEIVER

GPS receiver is essential to the proper operation of the device. PMU measurements rely on precise time synchronization. After a cold restart GPS receiver performs position lock-out. Acquisition time varies from few seconds to few minutes and highly depends on GPS receiver position, obstacles towards the open sky etc. For this reason, it is recommended to connect the GPS unit as soon as possible, to allow the device more time to synchronize with the GPS satellite system.

The Y-shaped PS2 cable, used to connect the GPS receiver to the device, also provides a power supply for the external modem/converter device. This allows the modem to continue operating during blackout conditions.

-  To ensure connectivity during blackouts when using Ethernet instead of GPRS, intermediate LAN switching equipment will also need to be powered through uninterrupted power supply (UPS) equipment. GPRS modem is powered through the device and is not affected by local blackouts, if the mobile network remains accessible. In both cases, all data is recorded to local device memory and can be retrieved later.

STER PMU device configures the GPRS modem automatically according to GPRS network provider settings. If SENA Ethernet modem is used, please consult the *STER PMU Ethernet Connection* manual.

3.1.3 CABLING SETUP WHEN USING THE GPRS MODEM

i If you are using the Ethernet communication option, refer to the *STER PMU Ethernet Connection* manual.

First, connect the **GPS receiver** by plugging the PS2 connector into the middle PS2 socket at the side panel of the STER PMU device. Then connect the second part of this cable to the **power socket** on the GPRS modem. Also make sure that the **SIM card** has been inserted.

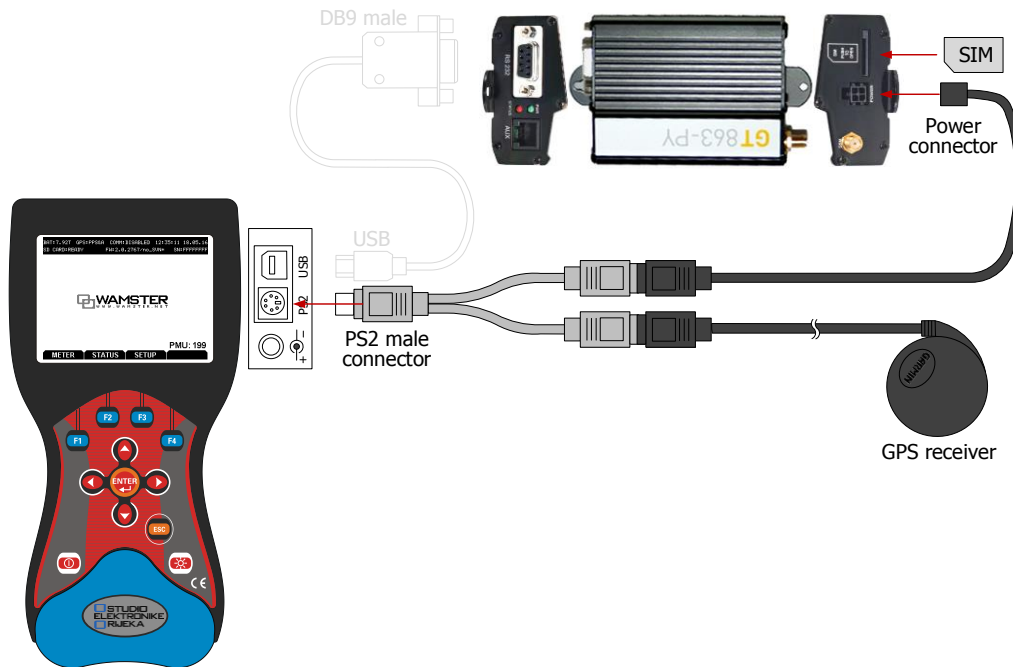

Figure 3.2: Connecting the GPS receiver and the GPRS modem power supply

Next, use the short serial cable (USB to DB9 male) to connect the STER PMU device to the **serial port** of the GPRS modem, as shown below:

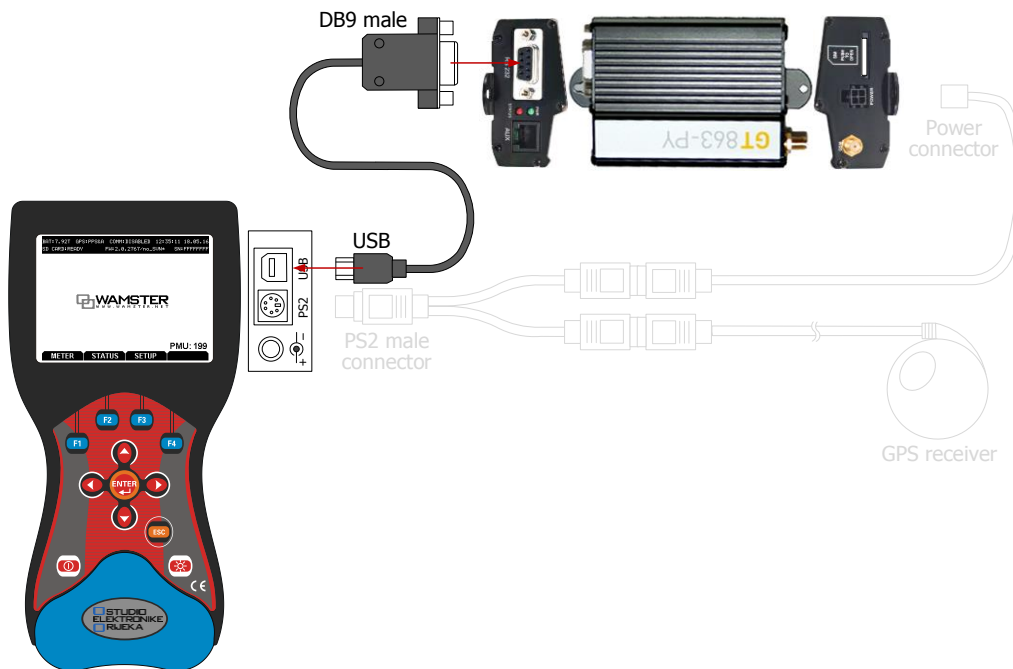

Figure 3.3: Connecting the serial (RS232) cable to the GPRS modem

Finally, connect the **GPRS antenna** to the provided socket at the GPRS modem.

PREPARING THE SIM CARD FOR FIRST USE

GPRS modem needs a SIM card with a valid internet data subscription plan to connect to the internet. SIM cards are usually protected by a PIN by default, and sometimes also need to be activated using a procedure specified by the mobile provider. It is recommended to disable the PIN protection to avoid locking the SIM accidentally.



While the device is connecting to the network, it will use the PIN number specified in device settings. If this number is wrong, the SIM card will be **locked** after 3 incorrect PIN attempts. Before entering the SIM card, it is advised to either **disable the PIN protection** by configuring the SIM card using a mobile phone (preferred), or make sure that the PIN entered in the device is correct.

GPRS MODEM LED INDICATORS

The GT863-PY modem has 2 LED indicators, green LED for **power supply** status and the red LED for **network status**. When the green (PWR) LED is on, it indicates that the modem is powered on.

Red (Status) LED indicates network service availability, according to the following table:

Red LED indications:

1	Blinking frequently (1s period, 0.5s on)	Searching for network / connecting / disconnecting
2	Blinking infrequently (3s period, 0.3s on)	Registered successfully, full service
3	Permanently off	Device turned off

3.1.4 POSITIONING THE GPRS ANTENNA AND THE GPS RECEIVER

GPS receiver must always be positioned outside the building, with a clear sky view. If the device is unable to lock to the synchronized time source for more than 10 minutes, try repositioning the receiver outside the building. If needed, additional GPS extension cables (5m, 10m) can be provided on request.

GPRS antenna can be placed indoors, but the signal can vary greatly depending on its position. If the device is having problems connecting, try repositioning the antenna.

3.2 CONFIGURING THE DEVICE FOR FIRST USE

3.2.1 MAIN SCREEN

After powering on, main device screen is shown:

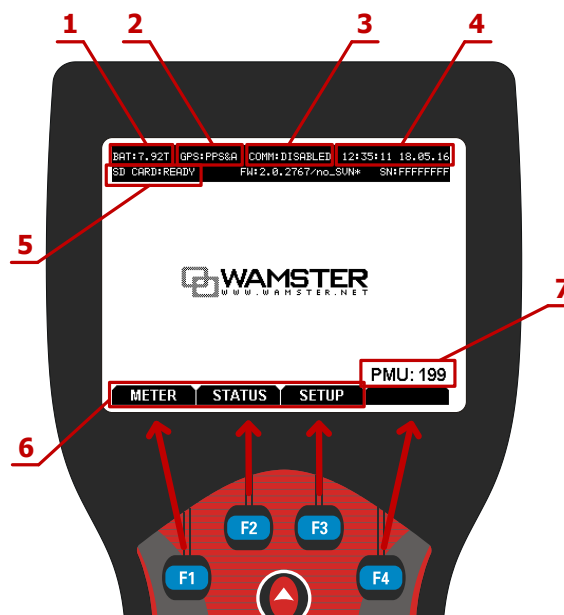



Figure 3.4: Startup screen

Main screen components:

1	Battery status	Displays current battery voltage and charging status
2	GPS status	GPS synchronization status: <ul style="list-style-type: none"> NO RCV: cable disconnected RCV: cable connected, but not synchronized PPS: synchronized but not reliable NOISE: receiving multiple pulses per second PPS&A: synchronized and reliable (full time synchronization)
3	Communication status	WAMSTER communication status: <ul style="list-style-type: none"> DISABLED: communication disabled INIT: initialization in progress SET CONN: configuring server address and port CONNECTING: trying to connect to the server CONNECTED: connection established
4	Date and time	Current time and date (hh:mm:ss DD.MM.YY). Time is synchronized through the GPS received, once the GPS status is PPS&A.
5	SD Card status	Status of the installed micro SD card: <ul style="list-style-type: none"> NO CARD: card not installed INIT: card initialization in progress (after inserting a new card) INVALID: card malfunctioned or unsupported READY: card initialized
6	Soft function keys (assigned actions)	These tags represent actions or submenus assigned to each of the four function keys (F1, F2, F3, F4). In the main screen, they represent main submenus: <ul style="list-style-type: none"> METER: displays the Meter screen, used to monitor measurements STATUS: displays the Status screen, showing system status SETUP: displays the Setup screen, used for configuring the device
7	Device ID	Shows the device ID when connected to the Wamster network. Each device has a unique WAMSTER ID, which is not user-configurable.

 GPS time source is fully locked when the device is showing the “PPS&A” status. If the status is intermittently changing between “PPS&A” and “NOISE”, it might indicate that the GPS cable is laid near an inverter or a different device which interferes with the GPS signal. In that case, try to relocate the cable until the status is steadily locked.

Note that the bottom bar in the startup screen always displays **Soft function keys**. While in the main menu, these keys correspond to METER, STATUS and SETUP menus. These functions can be accessed using F1, F2 and F3 function keys, respectively. On each screen, this bar will display different functions, and it’s always important to check them.

It is possible return to the main menu from any sub menu by pressing the Esc key (ESC) repeatedly.

3.2.2 SETUP MENU

To enter the Setup menu, press the F3 function key while located in the startup screen:

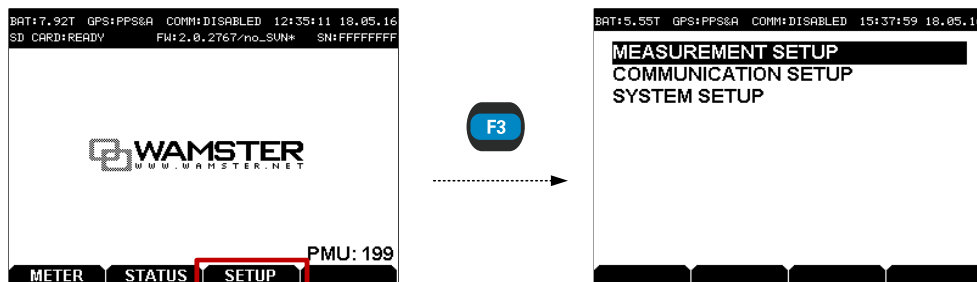



Figure 3.5: Accessing the SETUP menu



There are 3 setup menu items in the Setup screen:

- MEASUREMENT SETUP: used for configuring voltage and current measurement ratios,
- COMMUNICATION SETUP: used for configuring the modem,
- SYSTEM SETUP: advanced system settings.

To configure the modem:

- Press Down () to select the COMMUNICATION SETUP menu item,
- Then press Enter () to enter this screen.

3.2.3 COMMUNICATION SETUP MENU

-  **Important note:** before changing configuration settings, communication must first be disabled using the STOP soft function key ( while inside the COMMUNICATION SETUP screen).

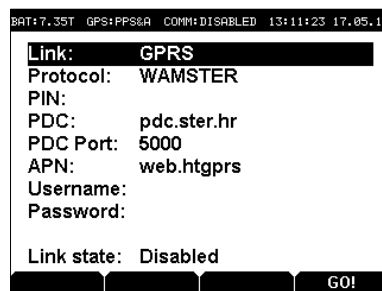



Figure 3.6: COMMUNICATION SETUP screen

STER PMU supports following types of communication links:

- **USB** (direct connection to a PC)
- **GPRS** (WAMSTER connection over a mobile network)
- **ETHERNET** (commonly used for standard IEEE C37.118.2 connections)

STER PMU also supports two communication protocols for transmitting synchrophasor data:

- **WAMSTER protocol**, optimized for GPRS networks,
- **IEEE C37.118.2 protocol**, suited for Ethernet networks due to larger overhead.

Depending on the protocol, two different sets of communication parameters can be configured in this menu. User can change the protocol using Left () and Right () keys while the **Protocol** menu item is selected.

-  If the WAMSTER protocol is selected, synchrophasor reporting resolution (fps) specified locally is ignored by the server and can only be configured through the **online web interface**.

WAMSTER PROTOCOL OVER THE GPRS MODEM

To connect to the Wamster server using the GPRS modem, make sure that the settings are configured as specified:

- Link: **GPRS**
- Protocol: **WAMSTER**
- PDC: **pdc.wamster.net**
- PDC port: **5000**

-  Note: For specific installations, PDC host and port number may be changed to connect to a different WAMSTER server. Please consult STER for custom settings if the standard WAMSTER service is not used.

In this case, make sure that you also configure all the properties related to your SIM card and mobile provider:

- PIN: **Personal Identification Number assigned to the SIM card**
- APN: **Access Point Name (provided by ISP)**
- Username, Password: **Needed if your ISP requires authentication**

Before inserting the SIM into the GPRS modem, it is recommended to put the SIM card into a phone device and change SIM settings to disable PIN identification completely. When handling multiple PMU devices with multiple SIM cards, it is easier to manage them when there is no need to keep track of the PIN number.



During the communication initialization sequence, the device will use the specified PIN number. If this code is wrong, SIM card will be **locked** after 3 incorrect PIN attempts. To unlock the SIM afterwards, it has to be inserted into a phone and unlocked by entering the correct PUK number. It is therefore recommended to either **disable the PIN protection completely** by configuring the SIM card using a mobile phone (preferred), or to make sure that the PIN entered in the device is correct.

WAMSTER PROTOCOL OVER THE SERIAL-TO-ETHERNET CONVERTER

To connect to the Wamster server using the SENA Serial-to-Ethernet converter, make sure that the settings are configured as specified:

- Link: **ETHERNET**
- Protocol: **WAMSTER**
- PDC: **pd.c.wamster.net**
- PDC port: **5000**

IEEE C37.118.2 PROTOCOL OVER THE SERIAL-TO-ETHERNET CONVERTER

To connect to the IEEE C37.118.2 compliant Phasor Data Concentrator, using the SENA Serial-to-Ethernet converter, make sure that the settings are configured as specified:

- Link: **ETHERNET**
- Protocol: **IEEE C37.118.2**
- PDC: **[user setting]**
- PDC port: **[user setting]**

For PDC settings, please contact your PDC network administrator.

Rate of data transmission (fps, or number of frames per second) can be selected in IEEE C37.118.2 mode by pressing **F1** and **F2** function keys.

FINALIZING THE COMMUNICATION SETUP

When the settings are correctly entered, press the **F4** button inside the COMMUNICATION SETUP screen to enable communication. Link state at the bottom will show the current initialization step until the device is connected.



Before starting the GPRS connection, double check that the PIN is correctly entered, or that the PIN protection has been disabled on the SIM card. During the initialization sequence, device will enter the PIN (if specified), which might lock the SIM if the parameter is incorrect.

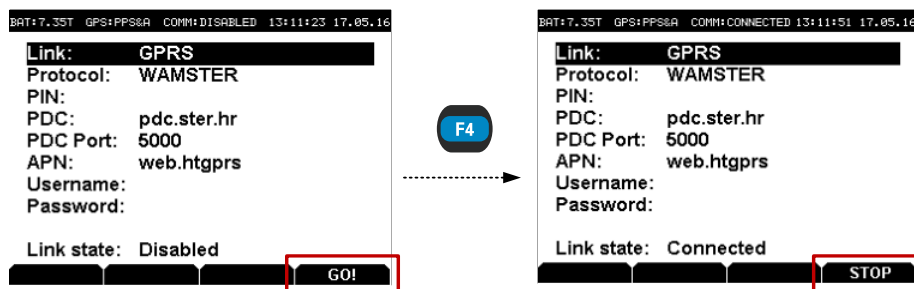



Figure 3.7: Accessing the SETUP menu

To stop the connection, press the **F4** button again. When finished, press **ESC** to exit the screen.

If settings were changed, it is recommended to save the settings by exiting from the COMM. SETUP screen. To do this, press  to exit from the screen. If the settings were changed, you will be prompted to accept the settings while exiting: press  to accept the settings.



Note: GPRS channel is both a data and a configuration/servicing channel. This connection should never be stopped manually during normal operation, except while changing parameters. If the connection is enabled, device will always automatically power on after a full power failure (if the batteries are fully depleted) and start communicating again.

TROUBLESHOOTING THE GPRS CONNECTION

After enabling the GPRS communication, the device will start the initialization sequence, with current step shown in the PMU State parameter inside the COMMUNICATION SETUP screen. Depending on the signal strength, it may take several minutes until the link is established. Additionally, connection might take longer to establish if this is the first time the device is connecting to the network at a new location.

However, if the device is cycling through the initialization steps, or appears stuck at a certain step, it is possible that cabling or parameters need to be rechecked. The following table shows the description of initialization steps shown as the PMU State parameter, and suggested troubleshooting steps if the sequence fails at a certain step.

Table 3.1: Troubleshooting GPRS initialization steps

Initialization step(s)	Description	Troubleshooting
00 to 01	Modem detection.	Check if the modem is properly cabled (refer to 3.1.3 <i>Cabling setup when using the GPRS modem</i>).
02 to 10	Basic initialization of the link between the device and the modem.	Modem is powered on, but device is unable to configure it. Check if the short serial cable is properly connected (refer to 3.1.3 <i>Cabling setup when using the GPRS modem</i>).
11 to 14	SIM card detection and initialization.	Check if a valid SIM card is properly inserted.
15	PIN unlocking.	If the SIM card is locked and a PIN has been specified, device will try to unlock the SIM in this step. If this step is failing, check that (i) the SIM card PIN protection is enabled and you have the corrected PIN, or (ii) the SIM card PIN protection is disabled and the specified PIN is empty. Note that the SIM card might be locked if the device made 3 incorrect PIN attempts. Note that the communication needs to be disabled using  before changing any settings.
16 to 17	Connecting to the mobile network.	If the device is unable to complete these steps, check that the modem antenna is properly connected and try to place it at a different position. If the device was disconnected for a longer period, these steps might take longer to complete (the initialization sequence might repeat several cycles from 01 to 16 before continuing).

18 to 20	APN, username and password configuration.	Check if APN, username and password are correctly entered in the COMMUNICATION SETUP menu. Note that the communication needs to be disabled using  before changing any settings.
21 to 22	Connecting to the WAMSTER server.	If these final steps are failing, the device is unable to reach the WAMSTER server. Check that the PDC Host and PDC Port settings are correct as specified in the 3.2.3 <i>Communication Setup menu</i> chapter, or as provided by STER. If these settings are correctly entered, also use a different mobile device to check if the server is temporarily offline (by visiting www.wamster.net). Finally, it may be possible that there are restrictions for certain TCP port usage imposed by the mobile ISP. In this case, please contact us through www.wamster.net for further assistance.

3.2.4 MANAGING THE DEVICE USING THE WAMSTER WEB INTERFACE

After the device has been connected, it can be managed through the Wamster web interface. To access the web interface, please visit www.wamster.net/users and log in using provided credentials.

After logging in, web interface should display statuses and management options for devices registered under your username. If some of the devices are not being shown, please contact the distributor to associate these devices with your account. During the installation and commissioning, it is useful to have a web enabled device and monitor the device status online, as it can provide additional details about the GPS status, wiring and scaling, and other information.

For detailed help on using the online web interface, please consult chapter 6: *Using the Wamster web interface*.

3.2.5 POWERING OFF

To prevent accidentally powering off the device while connected, **communication needs to be disabled** before powering off the STER PMU device. Communication can be disabled by pressing  inside the COMMUNICATION SETUP menu, while the communication is active.



To prevent from accidentally turning off the device at a remote location, PMU always **automatically restarts** after powering off whenever the charger (power supply) is present. To turn off the device completely, the charger cable must be removed prior to pressing the Power () key.

After the communication is stopped, press the Power () key. If the charger cable is connected, the device will automatically turn on again. Restarting the device does not lose data or settings, but several seconds of measurements will not be recorded until the device finishes the boot sequence and locks the GPS time signal.

If the charger is disconnected, the device will remain turned off until the charger is connected.

4 Working with the instrument

4.1 GENERAL CONSIDERATIONS FOR WIRING

Although the STER PMU can be accessed remotely to change configuration settings, it is nevertheless important to configure the wiring properly if the device is intended to run during longer periods of time, at a distant location.

- Make sure that phases are **correctly connected**. To avoid confusion, current connector I1 and voltage connector L1 should be connected to the same phase.
- Check the direction of the **current flow**. Current transformers should be mounted to measure the positive direction of the current flow, from supply to load.
- Under the influence of parasite impedances, voltage terminals which are not connected (floating inputs) can falsely measure unrealistically **high values**, creating large reading errors. It is therefore recommended to connect (short-circuit) all unused terminals to the neutral connector.
- Frequency estimation is done presuming a 3-phase system. If phases L2 and L3 are not used, they should be **connected to the neutral terminal**.



If 3W frequency measurements appear incorrect, check that the SYNCHRONIZATION setting is set to U1, and that voltage phase channels are not swapped (rotated). **All unused voltage channels should be connected to the neutral terminal.**



Note that the **Neutral terminal (N) is the reference potential terminal for all voltage measurements**, when measuring in 4W measurement mode (L1-N, L2-N, L3-N, GND-N). Green ground terminal (GND/L4) is an independent voltage channel, commonly used for measuring earthing potential, but should not be considered a reference channel.

4.1.1 CONNECTING VOLTAGE TERMINALS

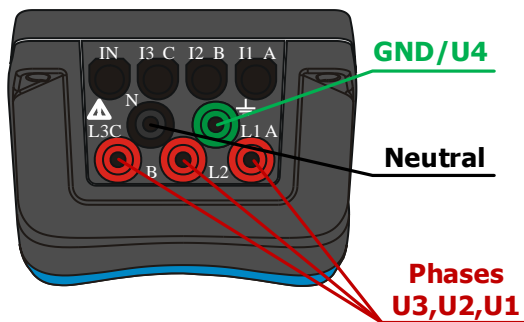

Figure 4.1: Voltage terminals

First, connect the neutral voltage terminal (N) using the **black** measurement cable, followed by three phase voltage terminals (L1, L2, L3) using **red** measurement cables.

Neutral terminal (N) is the reference terminal for all voltage measurements.

Green (GND) terminal can be used for measuring **earthing potential** by using the **green** voltage measurement cable.



Always connect the cables to the device **before** connecting them to live voltage.

4.1.2 CONNECTING CURRENT TERMINALS

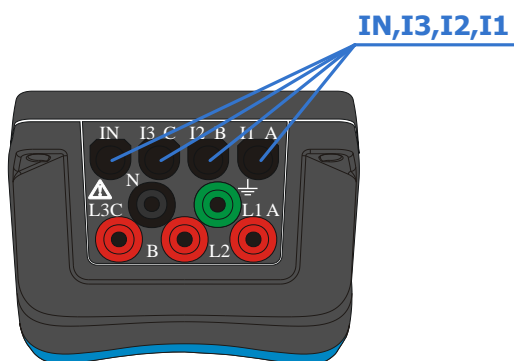

Figure 4.2: Current terminals

Connect the four current clamp connectors to the top 4 current terminals.



Always connect the cables to the device **before** mounting the clamps.



In case of usage of non-clamp-on sensors like A1037, connection to secondary CT circuits must be performed with extreme care.

4.2 CHANGING MEASUREMENT SETTINGS

In most cases, it is recommended to configure connection settings in the instrument **before** actually connecting the cables to the grid, to minimize the amount of inconsistent synchrophasor measurements in your database. Also, it is recommended to manually stop the remote data connection while doing such changes.

4.2.1 MEASUREMENT SETUP SCREEN

Measurement configuration is performed through the MEASUREMENT SETUP screen.

To access MEASUREMENT SETUP, make sure you are in the main (startup) screen, then press **F3** to enter the SETUP menu, followed by **ENTER** to enter the MEASUREMENT SETUP menu:

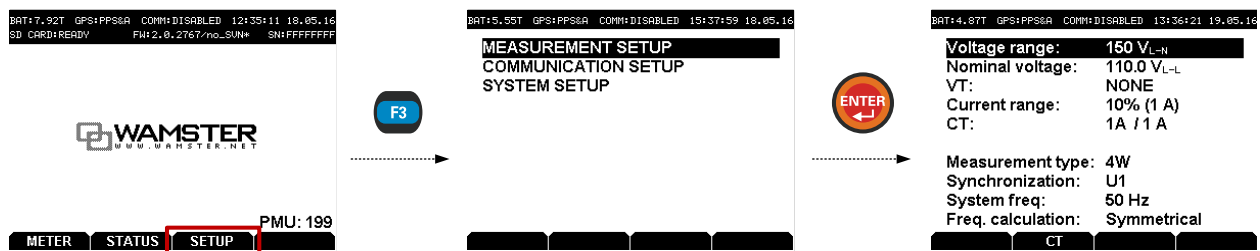

Figure 4.3: Accessing the MEASUREMENT SETUP menu

To adjust parameters inside the MEASUREMENT SETUP menu:

- Use up (▲) and down (▼) arrow keys to select individual parameters
- To change the currently selected parameter, use left (◀) and right (▶) arrow keys

Measurement settings are only applied **after you exit** the MEASUREMENT SETUP screen. To exit this menu and apply settings, press the **ESC** to exit the menu, and then confirm the action by pressing **F1**:

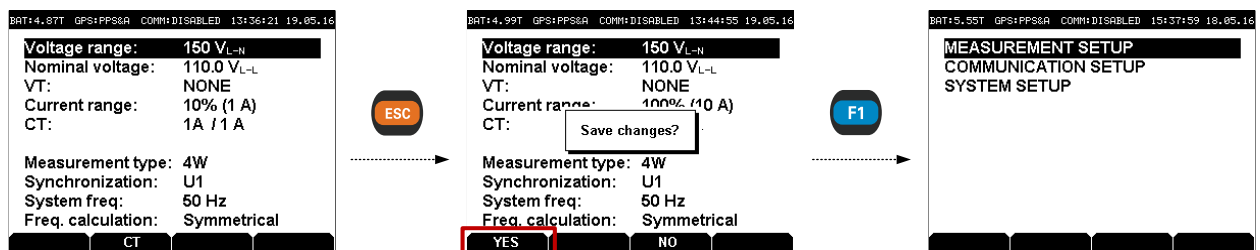

Figure 4.4: Modifying the Voltage Transformer ratios

Since the instrument’s primary functions are measuring and communication, intensive communication with the server or a reset of the communication link (in case of a weak GPRS signal coverage) may drastically slow down the instrument’s **user interface**, or even disable it for short periods of time.



For this reason, it is highly recommended that communication is held at minimum while measurement settings are being changed to improve your experience and time needed to enter parameters. This can be achieved by either setting the reporting speed to 1 FPS using the web interface, or completely disabling it through the Communication setup menu.

4.2.2 VOLTAGE MEASUREMENT

STER PMU can be connected to a LV, MV or HV power system using different voltage ranges. Three voltage ranges for each wiring configuration (4W or 3W) are available, described in the following tables:

Table 4.1: 4W measurement ranges

Range name	Default nominal voltage	Peak phase voltage	Meas. type	VT connection	Power system
150 V _{L-N}	110 V _{L-L} (64 V _{L-N})	235 V _{L-N}	direct / indirect	CONFIGURABLE	LV / MV / HV
300 V _{L-N}	400 V _{L-L} (230 V _{L-N})	500 V _{L-N}	direct	N/A	LV
1000 V _{L-N}	1000 V _{L-L} (580 V _{L-N})	2205 V _{L-N}	direct	N/A	LV

Table 4.2: 3W measurement ranges

Range name	Default nominal line voltage	Peak line voltage	Meas. type	VT connection	Power system
260 V _{L-L}	110 V _{L-L}	410 V _{L-L}	direct / indirect	CONFIGURABLE	LV / MV / HV
520 V _{L-L}	400 V _{L-L}	865 V _{L-L}	direct	N/A	LV
1700 V _{L-L}	1000 V _{L-L}	3815 V _{L-L}	direct	N/A	LV

i Always select the lowest range name with value equal or higher than the nominal input voltage; peak phase voltages in the table above should **not** be considered when choosing the range. For example, for 230VAC single phase measurement, range 150 V_{L-N} should **not** be used as it doesn't provide the necessary range for the 230VAC nominal phase voltage. Similarly, although the 1000 V_{L-N} range would provide the necessary range for measuring 230VAC, range 300 V_{L-N} would provide **better resolution** in this case.

Nominal voltage is always specified as **line voltage**, even on 4W measurement ranges where the range name is specified as phase voltage. Default nominal voltage value is provided depending on the selected range and can be changed by the user, **unless** voltage transformer (VT) ratio is specified – in that case it is fixed and equals the voltage value of the transformer primary side.

Apart from setting the correct range to get best possible resolution without clipping, setting the **correct nominal line voltage** is important for correct *per unit* (pu) voltage calculation used in event triggering and online analysis.

CONFIGURING THE VOLTAGE TRANSFORMER RATIO

On the 150 V_{L-N} / 260 V_{L-L} range, external voltage transformer (VT) ratio can be specified:

- Select Voltage range, then use left (◀) and right (▶) arrow keys to select the 150 V_{L-N} / 260 V_{L-L} range.
- VT should be displayed below nominal voltage and set to NONE by default.
- Use the down key (▼) to select VT, then left (◀) and right (▶) arrow keys to **enable VT**. It should show a previously configured setting or a default VT.
- With VT enabled, press the **F1** soft function key to enter the VT submenu, then use ▲, ▼ and **ENTER** to modify primary and secondary values, as shown in the figure:

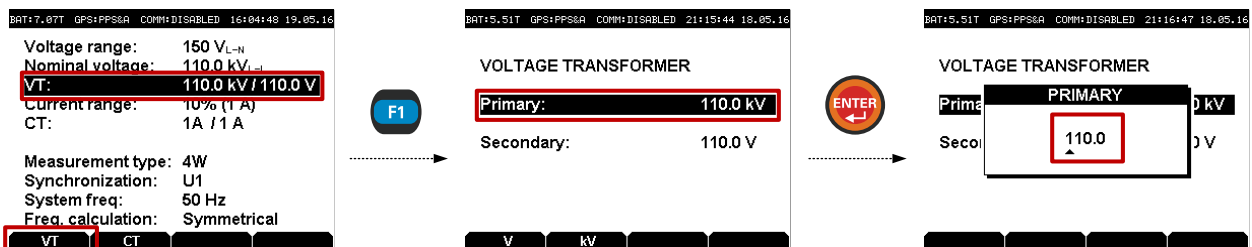



Figure 4.5: Modifying the Voltage Transformer ratios

By pressing the **F1** / **F2** soft function keys while the VT screen is shown (middle screen in the figure above), user can alternate between **V/kV** Primary voltage range, allowing greater flexibility when specifying ranges.

- While the VT setting is enabled, Voltage range is locked to 150 V / 260 V. To switch to a different range, first disable VT by selecting the VT entry and setting it to NONE using left (◀) and right (▶) arrow keys. Voltage range can then be changed to other values.

4.2.3 CURRENT MEASUREMENT

STER PMU performs only **indirect current measurements**, meaning its current inputs have to be galvanically isolated from the main circuit by using clamp-on current clamps or current transducers. Current transducer 5A/1V is used by default and is a part of the STER PMU package.

-  Failing to comply with the galvanic isolation requirement can result in measurement errors or even damaging the device.

CURRENT RANGE AND TRANSFORMATION RATIO

Current range can be configured directly in the MEASUREMENT SETUP screen:

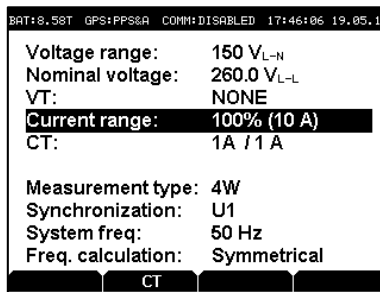

Figure 4.6: Measurement setup screen

Using the up (▲) and down (▼) keys select the **Current range** menu item, and then use left (◀) and right (▶) keys to select one of the two ranges:

- **100% input range** (0..10 A) or
- **10% input range** (0..1 A)

Field installed current transformers are usually **over-dimensioned** for a possibility to add new loads in future. In these cases, primary transformer current can be less than 10% of the rated transformer current.

- Moreover, xxxA/1A current transformers are more common at HV systems than xxxA/5A usually used in LV levels. For such cases it is recommended to **select the 10% current range**, which will allow increased precision. However, if currents larger than 120% of the nominal current are expected, 100% range should be used to avoid saturation.

To configure current transformer primary/secondary ranges press **F2**. When the CT screen appears, use the up (▲) and down (▼) keys to select the **Primary/Secondary** current transformer range and press **ENTER** key.

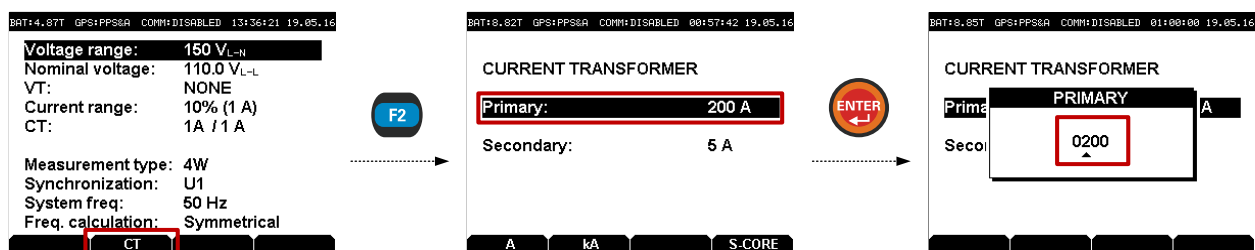



Figure 4.7: Current transformer ranges setup

Primary current range can be set from **999 kA** to **5A** (or 1A, depending on the Secondary range setting which can be either **1A** or **5A**). By pressing the **F1** / **F2** soft function keys, user can alternate **A/kA** Primary current range.

SPLIT-CORE MINIATURE CLAMPS

When paired with miniature split-core current clamps 10A/330mV (delivered on request), SPLIT-CORE setting needs to be enabled in the CT screen. To toggle SPLIT-CORE, enter the CT screen in the MEASUREMENT SETUP, like shown in the previous figure, and press the F4 () soft key.

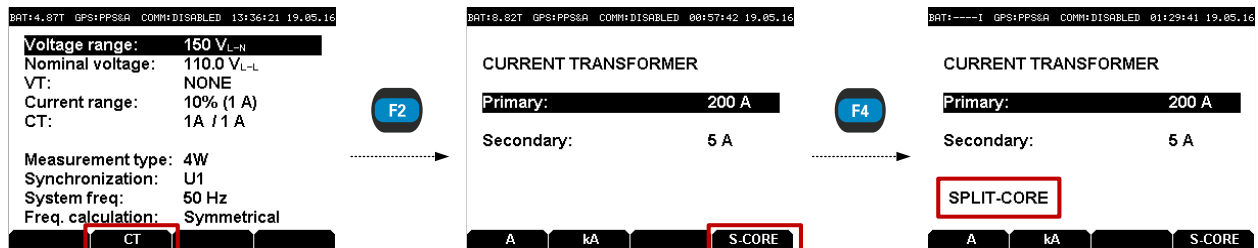

Figure 4.8: Toggling the SPLIT-CORE mode in the CT screen



Make sure that this option is **disabled** if miniature split-core clamps (10A/330mV) are not being used.

4.2.4 SYNCHRONIZATION CHANNEL

Synchronization input channel is used for A/D synchronization. Depending on the wiring configuration, it can be either voltage (U1 or U12), or current (I1).

In most typical cases, voltage channel should be used for A/D sync. However, if the voltage channel is distorted, current channel synchronization will provide a better reference (e.g. when connecting to power inverter outputs).

4.2.5 SYSTEM FREQUENCY

Depending on the **grid frequency**, it is possible to select 50Hz or 60Hz as the frequency for measurements. Allowed reporting speed values will also depend on this setting.

This parameter can also be modified in the MEASUREMENT SETUP screen.



Modifying the Frequency parameter (nominal grid frequency) requires a full reformat of the internal flash memory, which **deletes** all previous locally stored measurements. This process takes 3-4 minutes to complete. Although this operation does **not** impact the remote database, after the reinitialization of the PMU's memory, server will be unable to fetch old (historical) frames in order to populate data previously collected at lower reporting speed. This operation is usually done only prior to commissioning.

4.2.6 FREQUENCY CALCULATION

PMU can use two synchrophasor sources for frequency estimation:





- **Symmetrical:** for 3-phase, symmetrical systems, all 3 phases are used to improve estimation,
- **Phase:** for 1-phase systems, only a single phase is used for frequency calculation.

Symmetrical calculation should provide more stable frequency measurements. However, if only a single phase is connected (e.g. L1 - N), or the system has a specific wiring arrangement, symmetrical calculation might result in higher estimation error and should be set to **Phase**.

4.3 WIRING EXAMPLES

4.3.1 CONNECTING TO LOW-VOLTAGE POWER SYSTEMS

4-WIRE (4W) 3-PHASE SYSTEM

To configure the instrument for **4-wire** (4W) LV measurements (systems with a Neutral potential), start by entering the MEASUREMENT SETUP menu as described before (see Fig. 4.3). Using the up () and down () keys select the **Measurement type** menu item, and make sure that **4W** is selected using left () and right () keys:

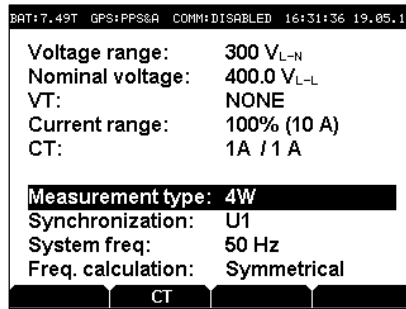

Figure 4.9: Measurement setup screen for 4-wire measurements



Typical voltage range for low-voltage connections is **300 V_{L-N}** if direct measuring is performed (e.g. connecting to a 3-phase 4-wire 400 V_{L-L} system, or measuring single-wire 230 V_{L-N} voltage). If nominal voltage is higher than 520 V_{L-L} (phase voltage of 300 V_{L-N}), you should use the higher range 1000 V_{L-N}. If using a voltage transformer, or measuring a MV/HV system over a VT, refer to the chapter 4.3.2 *Connecting to Mid- and High-Voltage power systems*.



Do not use the lowest range (150 V_{L-N}) for measuring voltages **higher than 150 V** unless connecting through a voltage transformer, because the signal will be clipped. If using a voltage transformer, keep in mind that the secondary transformer voltage should not exceed 150 V (260 V_{L-L}).

If 3-phase symmetrical system is being measured, set the Synchronization option to “U1” and Freq. calculation option to “Symmetrical”. Refer to chapter 4.2.6 *Frequency calculation* for additional information on frequency estimation algorithms.

To exit the menu and apply settings, press the **ESC** to exit the menu, and then confirm the action with **F1**. **Settings are not applied until they are confirmed.**

Instrument should be connected to the grid according to the following figure:

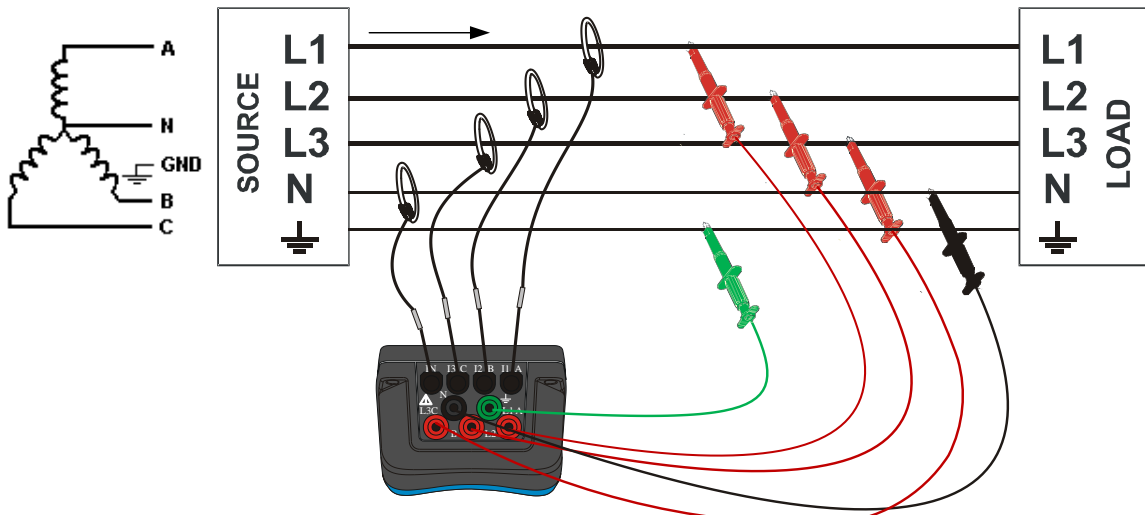

Figure 4.10: Wiring configuration for a 3-phase 4-wire system



Note that for direct measurement of currents at LV systems, xxxA/1V clamp-on current sensors have to be used.

1-WIRE (1W) SINGLE PHASE SYSTEM

Single phase LV measurements should use the same 4W setting as described in the previous subchapter. However, Freq. calculation should be set to “Phase” if only a single voltage phase is connected.

To configure the instrument for **single-phase** LV measurements, start by entering the MEASUREMENT SETUP menu as described before (see Fig. 4.3). Using the up (▲) and down (▼) keys select the **Measurement type** menu item, and make sure that **4W** setting is selected using left (◀) and right (▶) keys. Then select **Freq. calculation** and change it to **Phase**.

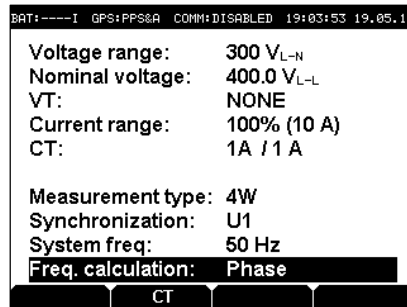

Figure 4.11: Measurement setup screen for single phase measurements

i Voltage range for a single phase measurement will depend on the range. For a 230VAC single phase system, **300 V_{L-N}** range should be used. For single phase voltages lower than 150VAC (RMS), **150 V_{L-N}** range should be used to provide better signal resolution. Similarly, maximum range of **1000 V_{L-N}** provides the highest voltage range, at the expense of resolution.

To exit the menu and apply settings, press the **ESC** to exit the menu, and then confirm the action with **F1**. **Settings are not applied until they are confirmed.**

Instrument should be connected to the grid according to the following figure:

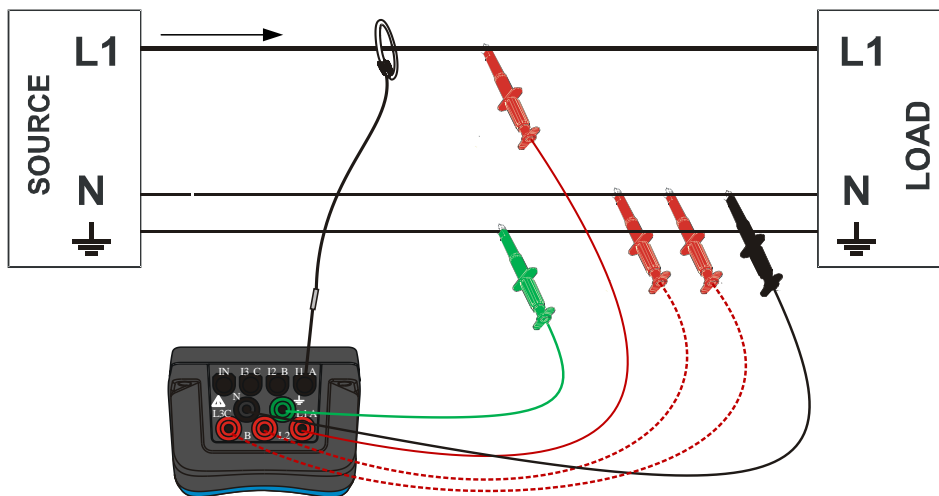

Figure 4.12: Wiring configuration for a single-phase system

i If channels L2 and L3 are not used, it is recommended to connect them to Neutral anyway, but this is not mandatory. However, to avoid errors in readings, Freq. calculation has to be set to **Phase** in MEASUREMENT SETUP.

3-WIRE (3W) 3-PHASE SYSTEM

To configure the instrument for **3-wire (3W)** measurements (systems without the Neutral), start by entering the MEASUREMENT SETUP menu as described before (see Fig. 4.3). Using the up (▲) and down (▼) keys select the **Measurement type** menu item, and make sure that **3W** setting is selected using left (◀) and right (▶) keys:

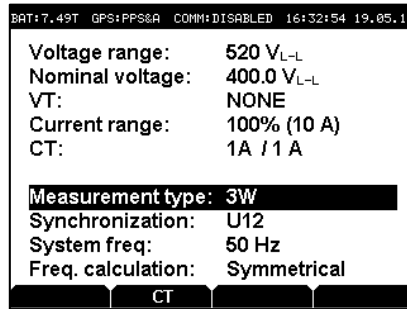

Figure 4.13: Measurement setup screen for 3-wire measurements

i When the Measurement type setting is switched to 3W, voltage range will show the channel range in **line voltage (L-L)**. Nominal voltage is always specified as line voltage. Depending on your actual nominal line voltage, choose the smallest range equal or higher to the nominal voltage to achieve best signal resolution.

To exit the menu and apply settings, press the **ESC** to exit the menu, and then confirm the action with **F1**.

Connecting the instrument to the grid should be done according to the following figure:

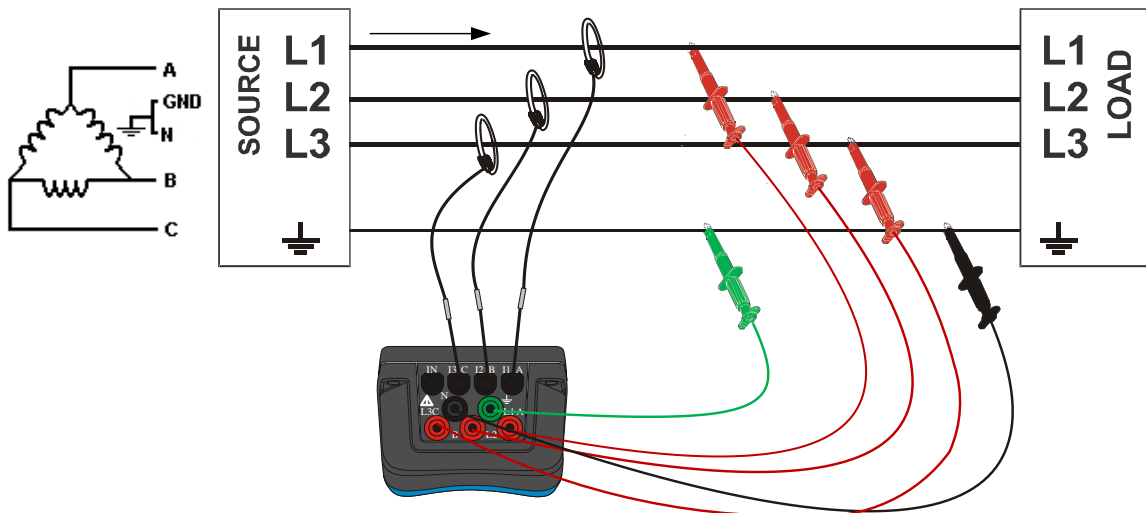

Figure 4.14: Wiring configuration for a 3-phase 3-wire system

4.3.2 CONNECTING TO MID- AND HIGH-VOLTAGE POWER SYSTEMS

In systems where voltage is measured at the secondary side of a MV/HV voltage transformer, the instrument voltage range should be set to **150 V** and scaling factor of that voltage transformer ratio has to be entered in order to ensure correct measurement. Current range and CT ratio should be also configured to match the measuring equipment.

These settings are changed in the MEASUREMENT SETUP screen, as described in chapter 4.2.1. To exit the menu and apply settings, press the **ESC** to exit the menu, and then confirm the action with **F1**.

Connecting the instrument to a 3-wire MV system should be done according to the following figure:

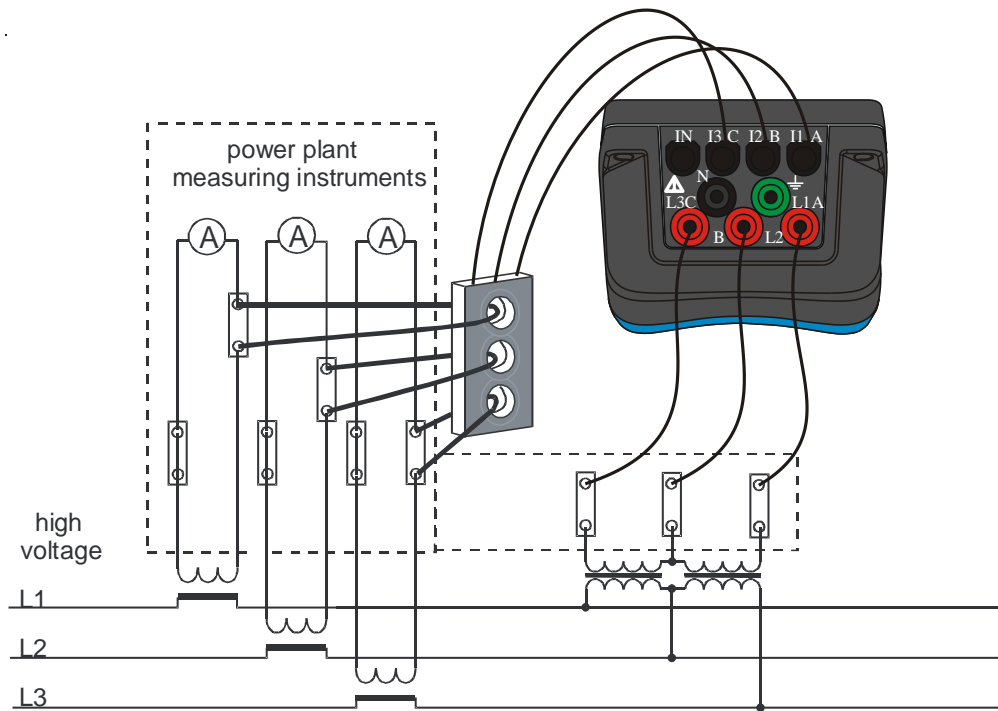

Figure 4.15: Connecting to existing on-site current transformers in a MV system, using a 3W connection

In case of a 4W system with VTs in a star connection, instrument should be connected according to Fig. 4.10.

4.4 VIEWING MEASUREMENTS ON THE DEVICE

STER PMU provides several screens for viewing measurements, which can be useful for verifying wiring and configuration during the on-site installation.

To access the METER menu, press **F1** in the main screen (if you are not in the main screen, press **ESC** several times to get to the screen with the WAMSTER logo displayed). After entering the METER menu, use up (**▲**) and down (**▼**) keys to select one of the provided views and **ENTER** to enter.

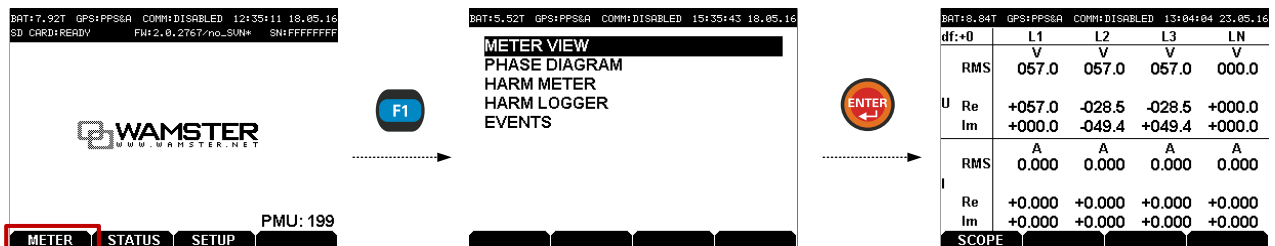

Figure 4.16: Accessing the METER menu and entering METER VIEW

4.4.1 METER VIEW / SCOPE

Meter view shows real-time phasor measurements. Precision of the displayed values will depend on the selected voltage/current ranges. To enter the scope view, press **F1** while inside the Meter view. To exit the scope and return to the Meter view, press **ESC**.

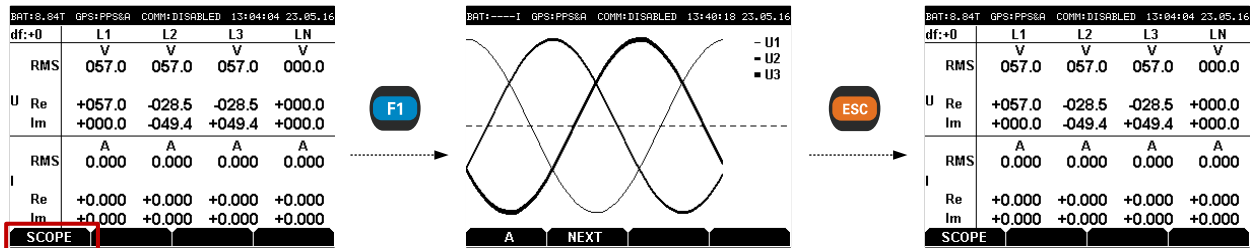

Figure 4.17: Switching between the Meter and Scope views

To switch between voltage and current display while inside the scope view, use the **F1** key. To toggle different phases, use the **F2** key.

4.4.2 PHASE DIAGRAM

Phase diagram is useful for quickly determining phase rotation. To view the phase diagram, select PHASE DIAGRAM in the METER menu, as described in figure 4.16.

4.4.3 HARMONICS METER

Accessible from the METER menu by selecting HARM METER, the Harmonics meter screen displays real-time voltage and current harmonic components. While in the HARM METER screen, use **F1** to toggle voltage/current display, and **F2** to scroll the harmonics list.

4.4.4 HARMONICS LOGGER

Also accessible from the METER menu, the HARM LOGGER screen shows **10-min aggregate values** for voltage and current harmonics and THD (minimum, maximum and average value for each 10-min interval).

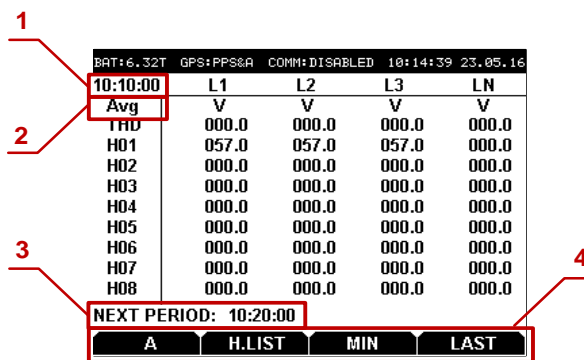

Figure 4.18: Harm Logger screen

Harm Logger screen components:

- | | | |
|----------|--|--|
| 1 | Currently displayed aggregation period | Displays the end timestamp of the currently displayed aggregation period. For example, if this value shows 10:30:00, then displayed harmonics are aggregates for the 10-min time period from 10:20:00 to 10:30:00.
To change the currently displayed period, use the left (◀) and right (▶) keys to move to older or newer periods, or press F4 to jump to the last recorded period. |
| 2 | Currently displayed aggregation property | Shows the currently displayed aggregation property: <ul style="list-style-type: none"> ▪ MIN: minimum value during the interval ▪ MAX: maximum value during the interval ▪ AVG: average value during the interval To iterate through MIN/MAX/AVG properties, use the F3 key. |
| 3 | Pending aggregation period | Displays the next end timestamp of the integration period. At this timestamp, device will save the aggregates and start recording the next period. |

- 4** Soft function keys These tags represent actions assigned to each of the four function keys:
- **F1**: switch between V (voltage) and A (current)
 - **F2**: scroll the harmonics list
 - **F3**: switch between MIN/MAX/AVG properties
 - **F4**: jump to the last (most recently finished) aggregation period

4.4.5 EVENTS

Local PMU event triggering is used to notify server of sub-second deviations which may not be detected by the server with lower frame reporting rates. Current PMU versions have a fixed number of triggers which can be enabled and configured through the WAMSTER web interface:

Table 4.3: Local event trigger types

PMU Trigger name	Description	Example WAMSTER (online) setting	Setting resolution
dFreq	Frequency deviation (offset from nominal value)	-0.250 .. +0.250 Hz	0.001 Hz
dFreq LP	Frequency to LP filtered frequency deviation (offset from low-pass filtered value, $\tau = 3s$)	-0.100 .. +0.100 Hz	0.001 Hz
U1/U2/U3/U4	Voltage deviation (offset from nominal value)	-10.0 .. +15.0 %	0.1 %
U1/U2/U3/U4 LP	Voltage to LP filtered voltage deviation (offset from low-pass filtered value, $\tau = 3s$)	-5.0 .. +5.0 %	0.1 %
-Sym	Negative symmetry deviation (max negative symmetry, low limit ignored)	0.0 .. +1.5 %	0.1 %
-Sym LP	Neg. sym. to LP filtered neg. sym deviation	-0.5 .. +0.5 %	0.1 %

For further information on setting these triggers through the WAMSTER web interface, consult the 6.3.3 *Local triggering* subchapter in the next chapter (6. Using the Wamster web interface).

To view the current event triggering configuration on the device, enter the EVENTS screen through the METER menu:

Quantity	Unit	Low	High	Actual	Elapsed
dFreq	Hz	-0.250	+0.250	-0.012	----
dFreq LP	Hz	DISABLED			----
U1	V	-046.2	+046.2	+005.5	----
U1 LP	V	DISABLED			----
U2	V	-046.2	+046.2	+005.0	----
U2 LP	V	DISABLLD			----
U3	V	-046.2	+046.2	-172.9	LO 11 s
U3 LP	V	DISABLED			----
U4	V	DISABLED			----
U4 LP	V	DISABLED			----
-Sym	V	+000.0	+000.2	+097.3	HI 11 s
-Sym LP	V	DISABLED			----

Figure 4.19: Events screen

Events screen components:

1	Configured deviation limits	Low and high limits are shown in specified units (Hz or V). If the trigger is disabled, "DISABLED" is shown instead.
2	Actual (currently measured) deviation	Shows the current deviation from the nominal value (Hz or V)
3	Trigger status	If the event is active, this column will display LO (actual value below low-limit) or HI (actual value above high-limit).
4	Time since event last triggered	Shows the number of seconds elapsed since the event was triggered. This value will be shown even if the event is no longer active, until it reaches more than 999s.

5 Instrument maintenance

5.1 CHANGING BATTERIES

STER PMU uses six rechargeable NiMh batteries, type HR 6 (size AA) for battery backup. Make sure that the power supply adapter/charger and measurement leads are disconnected and the instrument is switched off before opening the device.

Turn the device upside down as shown on the picture below to keep the batteries from falling out after the lid is opened. Using a coin or a screwdriver, unscrew the battery lid and remove it.

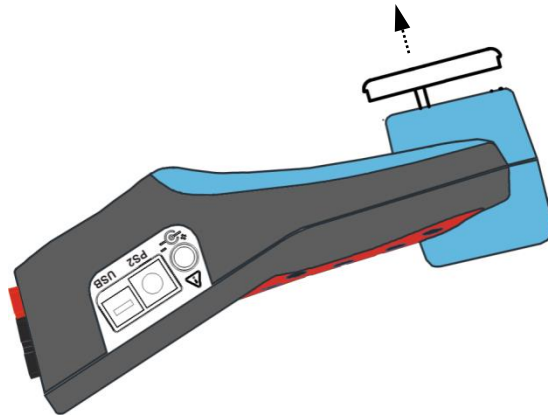

Figure 5.1: Removing the battery holder

Remove old batteries and insert new ones as shown in figure below:

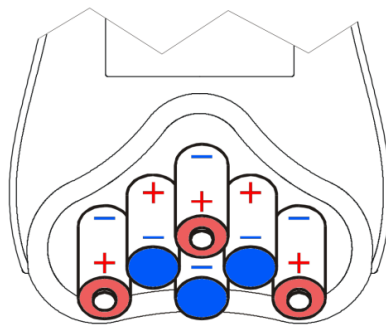

Figure 5.2: Battery placement (positive shown in red, negative in blue)



Warning! Always double-check that the polarities are correct **before** placing the battery holder lid to avoid damaging the equipment.

When batteries are in place, tilt the instrument as shown in the first picture, and screw the lid back on.

5.2 SAFETY CONSIDERATIONS



Hazardous voltages exist inside the instrument. Always turn off the instrument, disconnect all test leads and remove the power supply cable before removing battery compartment cover.

- If the instrument is not going to be used for long periods of time, it is advisable to remove all batteries from the battery holder after powering it off.
- Always turn off the instrument before opening the battery compartment cover.
- Use only the original power supply adapter/charger to avoid possible fire or electric shock.
- Rechargeable NiMh batteries type HR 6 (size AA) are recommended. The charging time and the operating hours are given for batteries with a nominal capacity of 2500 mAh.
- Never use standard batteries while power supply adapter/charger is connected to prevent explosion!
- Do not mix batteries of different types, brands, ages, or charge levels.
- When charging batteries for the first time, make sure to charge batteries for at least 24 hours before switching on the instrument.

5.3 BATTERIES

Instrument contains rechargeable NiMH batteries. These batteries should only be replaced with the same type as defined on the battery placement label or in this manual.

If it is necessary to replace batteries, all six have to be replaced. Ensure that the batteries are inserted with the correct polarity; incorrect polarity can damage the batteries and/or the instrument.

PRECAUTIONS ON CHARGING NEW BATTERIES OR BATTERIES UNUSED FOR A LONGER PERIOD

Unpredictable chemical processes can occur when charging new batteries or batteries that were unused for a longer period of time (more than 3 months). This effect, sometimes referred to as *memory effect*, can affect both NiMH and NiCd batteries. As a result, device operation time can be significantly reduced.

Therefore it is recommended:

1. To completely charge the batteries.
2. To completely discharge the batteries (can be performed with normal working with the instrument).
3. Repeating the charge/discharge cycle for at least two times (four cycles are recommended).
4. When using external intelligent battery chargers one complete discharging /charging cycle is performed automatically.

After performing this procedure a normal battery capacity should be restored, and operation time of the device should meet the data in the technical specifications.

NOTES

The charger in the instrument is a pack cell charger. This means that the batteries are connected in series during the charging so all batteries have to be in similar state (similarly charged, same type and age). Even one deteriorated battery (or just of another type) can cause an improper charging of the entire battery pack (heating of the battery pack, significantly decreased operation time).

If no improvement is achieved after performing several charging/discharging cycles the state of individual batteries should be determined (by comparing battery voltages, checking them in a cell charger etc). It is very likely that only some of the batteries are deteriorated.

The effects described above should not be mixed with normal battery capacity decrease over time. All charging batteries lose some of their capacity when repeatedly charged/discharged. The actual decrease of capacity versus number of charging cycles depends on battery type and is provided in the technical specification of batteries provided by battery manufacturer.

5.4 POWER SUPPLY CONSIDERATIONS



Warning!

- Use only charger supplied by manufacturer.
- Disconnect power supply adapter if you use standard (non-rechargeable) batteries.
- When using the original power supply adapter/charger the instrument is fully operational immediately after switching it on. The batteries are charged at the same time, nominal charging time is 4 hours.
- The batteries are charged whenever the power supply adapter/charger is connected to the instrument. Inbuilt protection circuit controls the charging procedure and assure maximal battery lifetime.
- If the instrument is left without batteries and charger for more than 2 minutes, time and date settings are reset.

5.5 CLEANING

To clean the surface of the instrument use a soft cloth slightly moistened with soapy water or alcohol. Then leave the instrument to dry totally before use.



Warning!

- Do not use liquids based on petrol or hydrocarbons!
- Do not spill cleaning liquid over the instrument!

5.6 PERIODIC CALIBRATION

To ensure correct measurement, it is essential that the instrument is regularly calibrated. If used continuously on a daily basis, a six-month calibration period is recommended, otherwise annual calibration is sufficient. Contact your distributor for calibration details.

5.7 SERVICE

For other repairs, either under or outside of warranty, please contact your distributor for further information.

5.8 TROUBLESHOOTING

- If *Esc* or *Enter* button is held pressed while switching on the instrument, the instrument will not start. In that case, batteries might need to be removed before starting the instrument again. After the batteries have been reinserted, power on the instrument without holding any keys to start it normally.
- If the instrument is switched on flat batteries and without power supply adapter connected, power supply circuitry may lock itself. In that case, the instrument will not power up even with external power supply adapter is connected afterwards. To remedy this situation, batteries must be removed and re-inserted, and the instrument must be switched on with the power supply adapter. After the successful boot, batteries should be charged for at least a half of hour to avoid recurrence of this problem on next measurement session.

6 Using the Wamster web interface

After the device has connected to the server, it can be monitored and managed through the Wamster web interface.

Wamster web interface provides a simple way to monitor and configure your device, as well as download (export) measured data from the cloud storage.

6.1 MINIMAL CONFIGURATION

To access the Wamster, you will need a web enabled device (personal computer, a tablet, or a smartphone) with an installed web browser and JavaScript enabled.

Although Wamster uses standard-compliant web technologies in order to support a wide range of Internet browsers, some browsers (like Microsoft Internet Explorer prior to version 10) do not fully conform to www standards. While they are officially supported by Wamster, using one of the following browsers is recommended for safety, speed and better browsing experience (newest download links shown for each browser):

- Google Chrome 9 or newer: www.google.com/chrome
- Mozilla Firefox 3.6 or newer: www.getfirefox.com
- Microsoft Internet Explorer 10 or newer: www.microsoft.com/windows/downloads/ie
- Opera 10 or newer: www.opera.com/download
- Apple Safari 5 or newer: www.apple.com/safari

6.2 SIGNING IN TO WAMSTER

To access the web interface, visit www.wamster.net/users using a web browser of your choice. If you were not previously signed in, you will be asked for your credentials.

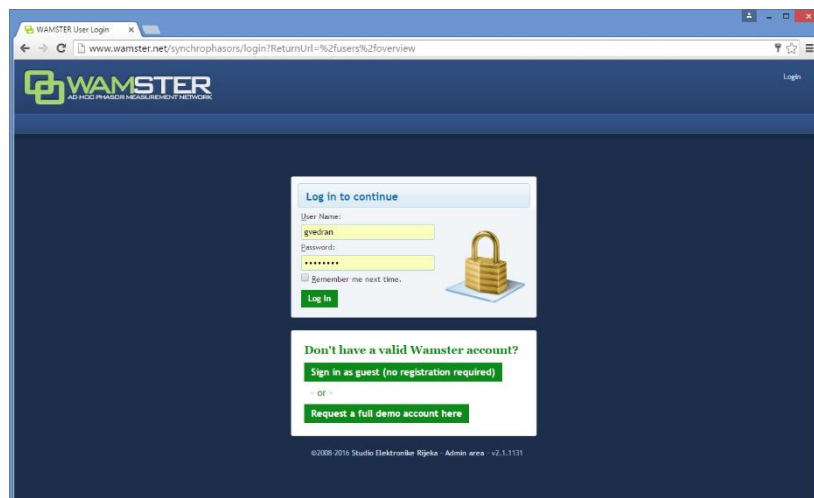

Figure 6.1: Authentication form shown when accessing Wamster



In order to sign in, you will need a username/password combination provided to you via e-mail. If you enter an incorrect password several times, your account may be locked out. If you believe your account has been locked, or have any troubles signing in, please contact us at support@wamster.net to resolve this issue.

If signed successfully, you will be redirected to the **Overview** page. Navigation menu will be changed to include advanced options, and user status will be shown in the upper right corner:

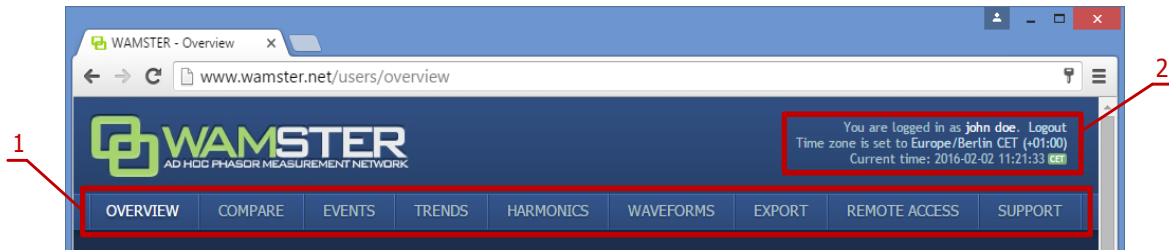

Figure 6.2: User area: 1. navigation menu, 2. login status / Logout link / Time zone settings

After logging in, at the top of each Wamster there is the navigation menu (marked with 1 on the figure above), providing access to different pages, and the user status/time area (marked as 2).

To log out, click the Logout link button in the upper right corner of the web page. This area will also show current server time, shown in your browser’s reported time zone. To use a custom time zone, click on the zone name in the upper right corner to show a list of zones. This setting is stored as a site-wide cookie and is respected across the entire Wamster site.

If your local browser’s time differs by more than 5 minutes compared to the server time, it will be shown in red to indicate that you need to synchronize your local time. Having your local clock synchronized with the server improves Wamster experience when examining online trends and comparing devices.

6.3 OVERVIEW

First navigation item and the default page after logging in is the Overview page, which shows a general overview of your devices. Statuses and management options for individual devices registered under your username can be seen, as shown on the figure:

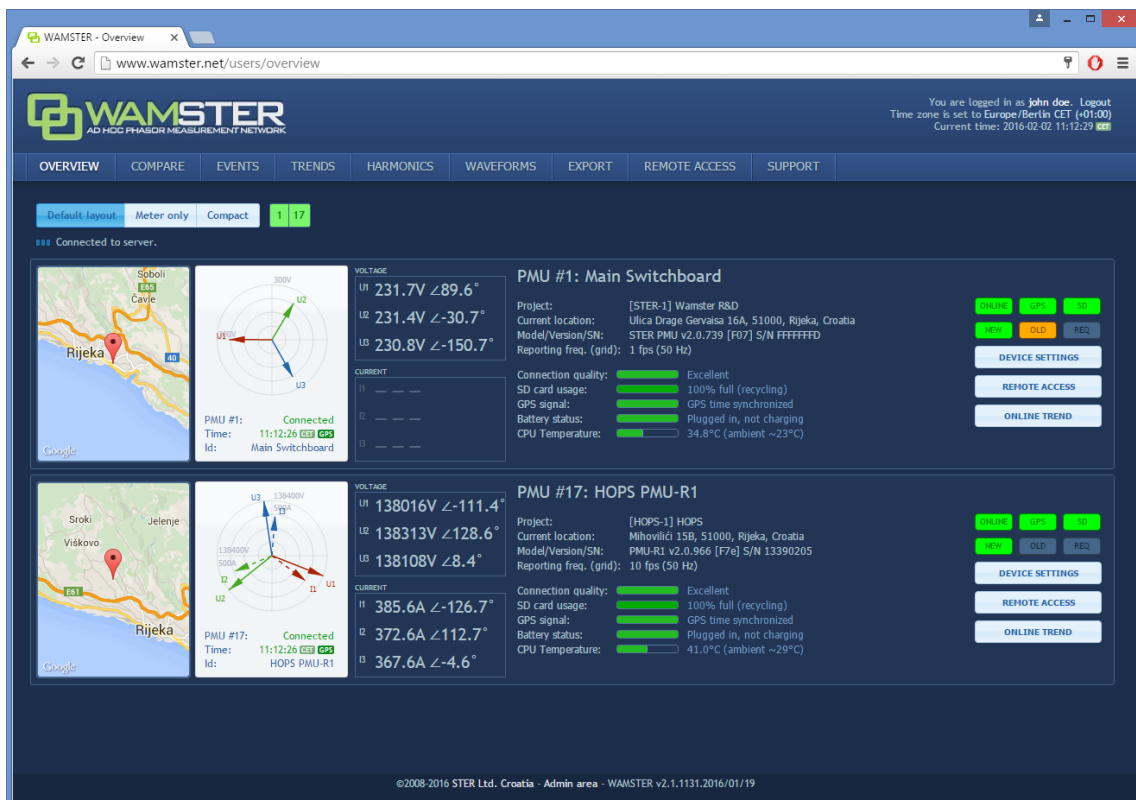

Figure 6.3: Overview page, showing devices for the currently logged in user



Measurements from multiple devices shown in the Overview page are **not** displayed with a synchronous timestamp, i.e. each device can have a different timestamp depending on network conditions. To perform a synchronized comparison, use the **Compare** or **Map** pages, described in the following chapters.

For each device there is a separate panel showing various status indicators:

- phase diagram with voltage and current vectors displayed (updated in near real-time),
- map indicating device’s current location, as reported by its GPS device,
- device ID and custom name
- address, as reported by its GPS device
- device model, serial number and firmware version
- nominal grid frequency [Hz] and current reporting speed [fps]
- connection quality, SD card usage info and GPS signal information

On the right side of each panel, there are several visual status indicators and buttons for accessing device settings:

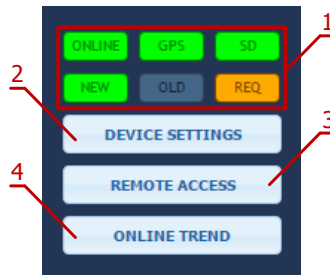

Figure 6.4: Visual status indicators and command buttons

Visual status indicators and command buttons:

1	Status indicators	<p>First row of indicators shows statuses:</p> <ul style="list-style-type: none"> ▪ ONLINE: when green, device is connected ▪ GPS: when green, GPS reliable ▪ SD: when green, SD card inserted and functional <p>Second row of indicators blink to indicate that the communication is live:</p> <ul style="list-style-type: none"> ▪ NEW: if green, up-to-date synchrophasor frame received ▪ OLD: if orange, frame has been received from instrument’s local memory ▪ REQ: if orange, there is a pending request for old frames (either because of a bad data connection, or because user requested frames at a different reporting rate)
2	Device Settings button	Clicking on this button opens the Device Settings form, which can be used to configure the device
3	Remote Access button	Clicking on this button shows the Remote Access page, which can be used to connect to the instrument and operate it remotely
4	Online Trend button	Clicking on this button shows the Trend page in Online mode, with this device selected. This allows users to quickly get a recent measurements trend (last 5 minutes).

To change the custom name of a device and its reporting frequency, click on the Device Settings button to open the Device Settings form.



Depending on granted user access privileges, some buttons might be disabled (grayed-out). Users usually have administrative access rights for their owned devices, but may also have read-only devices from STER for reference or demonstration purposes.

6.3.1 DEVICE SETTINGS FORM

Device Settings form is the central place for changing all user applicable device settings. At the top of the dialog (shown in figure 6.5) there are tabs which are used for switching between various settings panels (marked as 1 in the figure).

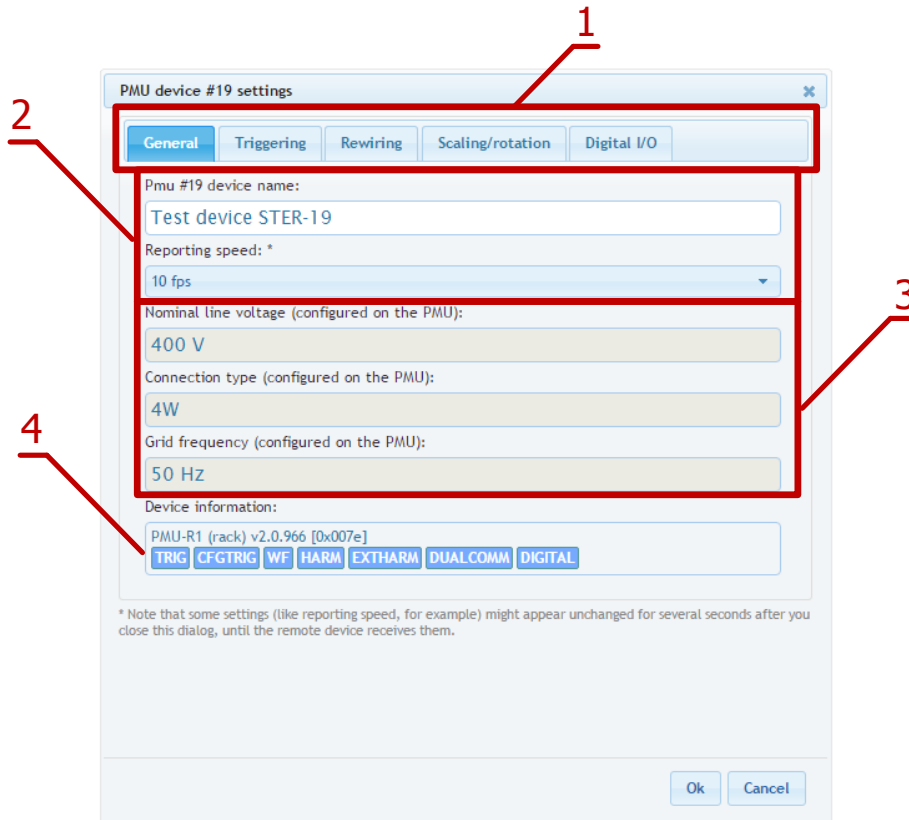

Figure 6.5: Device Settings form can be used to change the various device settings

6.3.2 GENERAL SETTINGS

Fields marked with (2) on the image are used to change device’s name and reporting speed.

Reporting speed is the default number of data frames per second that this device should send to the server, under normal operating conditions. During triggered events, or on user request, server can automatically increase this value to get full resolution (synchronized) historical data from the device. Likewise, when mobile network conditions are inadequate, server can temporarily reduce the real-time reporting speed until the connection permits the user specified reporting speed.



To learn more about the Wamster communication protocol, please consult online manuals and whitepapers at www.wamster.net, specifically the [Wamster System Implementation Details](#) whitepaper. Additional whitepapers, datasheets and catalogs can be found at www.wamster.net/w2/features/wamster-whitepapers-datasheets-catalogs.

Settings marked with “3” (Nominal line voltage, Connection type and Grid frequency) cannot be changed online, they are configured on the PMU and sent to Wamster. Note that Nominal voltage is always specified as *line* voltage, regardless of the connection type.

Final group in this tab, marked with “4”, indicates the type of your PMU device, its firmware version, and currently enabled functionalities:

1	TRIG	Triggering: Device supports local triggering with fixed (PMU side) thresholds. PMUs with local triggering detect several event types and report them to the server, which then requests these data frames at full resolution for further processing. This allows the user to lower the default reporting speed while still getting sub-second events when they happen.
2	CFGTRIG	Configurable triggering: Device supports local triggering with configurable (server side) thresholds. This is an extension of the TRIG functionality, where thresholds can be configured inside the device settings form. If this option is not enabled, device used default thresholds (+/- 10% Voltage, +/- 0.1 Hz frequency).

3	WF	Waveform Recorder: Device performs continuous 8-channel waveform (oscillogram) recording. If this functionality is enabled, the device will continuously record waveform data and store it locally (4.5 days of measurements on 32GB cards). It will also reserve most of the external SD card memory for oscillograms, so local PMU data will also be kept for 4.5 days (32GB). During events, or on user request, oscillograms will be downloaded to the server.
4	HARM	Harmonic Aggregates: Device records 10-minute harmonic aggregates (min, max, avg) for all channels, for up to 30 th harmonic + THD. If this functionality is enabled, server will automatically retrieve harmonics at the end of each aggregation period. This functionality uses internal flash memory to store 10-min aggregates for the period of 17 hours.
5	EXTHARM	Extended Harmonics: Improved harmonics recorder, stores 10-min aggregates for the last 17 days.
6	DUALCOMM	Dual Communication Module: Device is equipped with a communication module capable of simultaneously transmitting data using two protocols (WAMSTER and C37.118), to different targets, Ethernet + GPRS. This feature is useful when the project requires simple integration with standard C37.118 PDCs, but additional Wamster features also need to be utilized.
7	DIGITAL	Digital I/O: PMU device is equipped with digital inputs and outputs, which can be monitored and activated from the Wamster server programmatically.

Some settings (like reporting speed, for example) might appear unchanged for several seconds after the dialog is closed, until the remote device receives them.



Note also that the form contains Measurement setup settings intended to allow post processing (scaling and phase swapping) of signals. This feature is currently reserved for future use and can be enabled on request.

6.3.3 LOCAL TRIGGERING

If the PMU device supports the CFGTRIG functionality, Triggering tab can be used to configure local thresholds, as shown in the figure below. Each triggering rule can be enabled or disabled separately by selecting the checkboxes above low/high threshold input boxes.

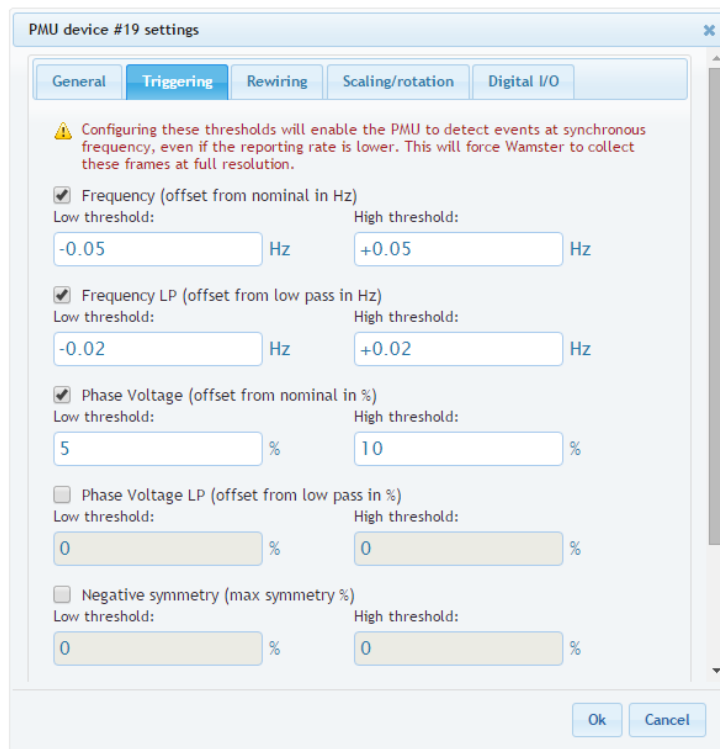



Figure 6.6: Triggering tab enables configuration of local (PMU side) event triggering

Thresholds for voltage-related quantities is specified as p.u. (percent of nominal value), where the nominal value is configured on the device and can be seen on the General tab.

-  Local triggering thresholds are separate from Wamster’s event triggering system (which is applied to incoming measurements). These settings are uploaded to the PMU device so that the device itself can perform them locally, on synchronized data, and report detected events to Wamster. **Additional information about the PMU local triggering system can be found in the chapter 4.4.5 Events.**

6.3.4 REWIRING RULES

Using the Rewiring tab, each of the 8 input channels (U1-U4, I1-I4) can be rewired (routed) to a different channel, or disabled (disconnected):

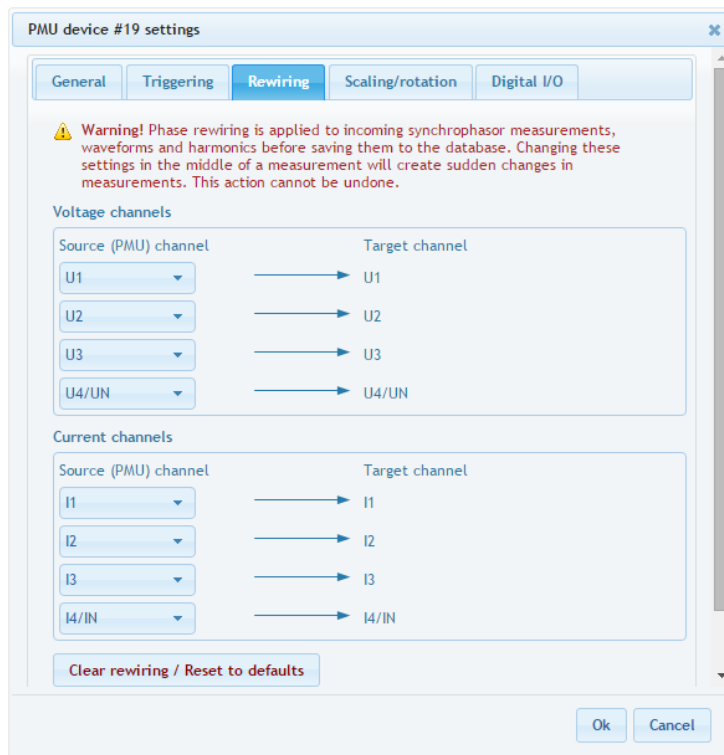



Figure 6.7: Using the Rewiring tab, it is possible to disable certain channels, or correct incorrect wiring and rotation

Rewiring is applied to all incoming measurements, including synchrophasors, waveforms and harmonics. A single source channel can also be duplicated, i.e. routed to multiple different target channels, each of which will act like a separate channel for analysis, triggering or export. To quickly clear all rewiring rules to default, use the Clear rewiring / Reset to defaults button at the bottom of the panel.

-  It is recommended to hide channels which are not physically connected anywhere, by setting their source to *Not connected*. Unconnected channels can pick up noise, so disconnecting them through the interface will make analyzing other channels easier and more readable.

For more complex scaling and rotation corrections, the Scaling/Rotation tab can be used, but rotation (phase angle) corrections on that tab are applied only to synchrophasors data.

6.3.5 SCALING/ROTATION SETTINGS

To add different scaling or apply phase angle corrections to each channel, use the Scaling/Rotation tab.

-  Input channels in the Scaling/Rotation tab are rewired output (target) channels from the Rewiring tab, not actual channels from the PMU device.



Scaling settings (along with rewiring on the previous tab) are applied to all measurements, but rotation settings (angle corrections) are **only applied to synchrophasors**. Harmonic aggregates and oscillograms (waveforms) are not affected by these settings. This can result in inconsistencies between measurements and must be taken into account when analyzing waveform data collected from the PMU device.

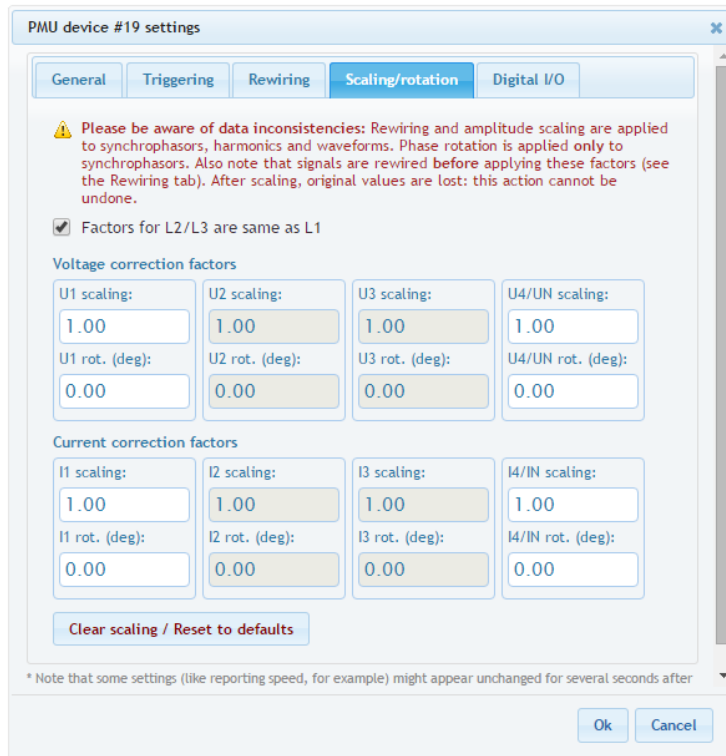

Figure 6.8: Scaling/rotation tab can be used to further correct measurements after rewiring

If factors for phases L2 and L3 are same as L1, user can mark the checkmark at the top of the panel and only enter values for phase L1. Fourth channel (U4 or UN) settings are always applied separately.



If phase correction angles are a multiple of 120 degrees, consider using the rewiring tab instead of entering values in degrees, to get the correction applied to harmonic and waveform channels, as explained in the previous chapter.

6.3.6 DIGITAL I/O

If the PMU device contains digital inputs and outputs, it is possible to view their status and manually change output values using the Digital I/O tab. Depending on the device type, different number of inputs/outputs may be shown:

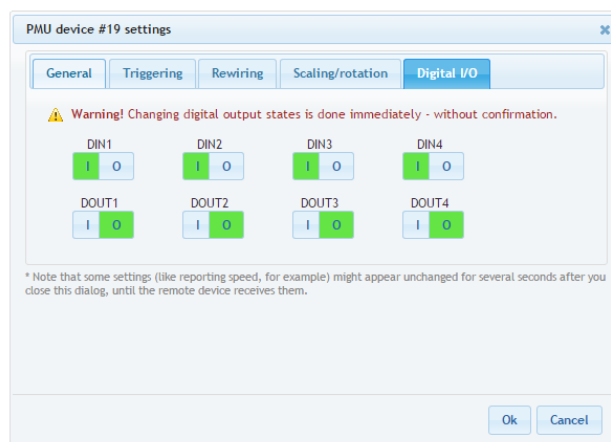

Figure 6.9: Digital inputs and outputs can be controlled using the last tab

6.4 SYNCHRONIZED COMPARISON

To compare real-time synchrophasors of your devices with a synchronized timestamp across all devices, use the **Compare** page, accessible from the navigation menu. Depending on the network conditions, this page will show measurements with a certain delay to ensure phasors from all devices are collected.

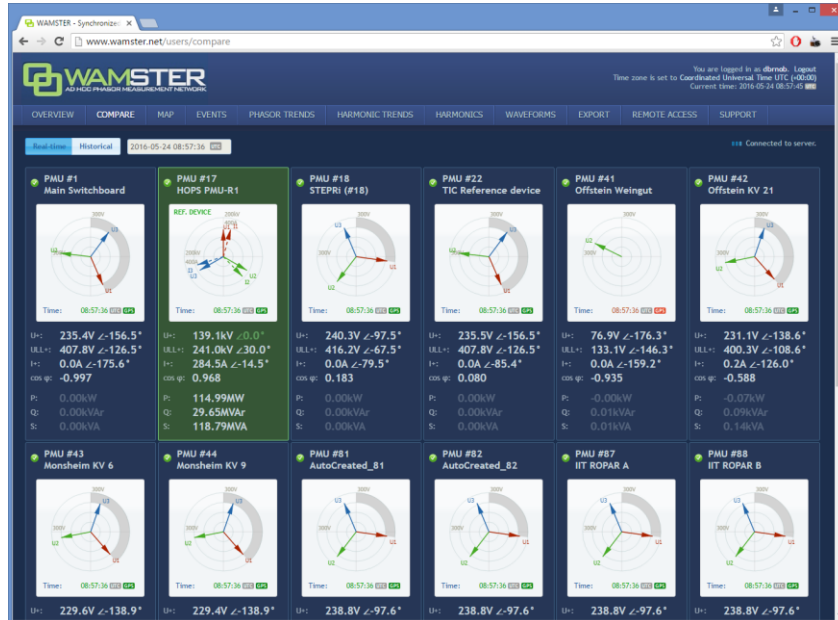

Figure 6.10: Measurement comparison page allows real-time and historical comparison. Selected reference device is shown in green

Each diagram shows voltage and current phasors for the related device, with the angle **relative to the currently selected reference device**. Reference device is shown in green, and the positive symmetry vector for this device is set to 0.0°. Clicking on a different device will set it as the current reference device and all vectors will be rotated accordingly.

Below each phasor diagram there is a table with several measured values: U+ (voltage positive symmetrical component), ULL+ (line voltage pos. sym. component), I+ (current pos. sym. component), cos φ, as well as active, reactive and apparent power.

i Current phasor angle is shown relative to the U+ phasor of the **same device** (not relative to the reference device).

To enable better visualization of the relative rotation, positive symmetry angle difference is drawn with a gray arc on each phasor diagram, as seen in the right phasor diagram in the figure below (showing -59° relative angle):

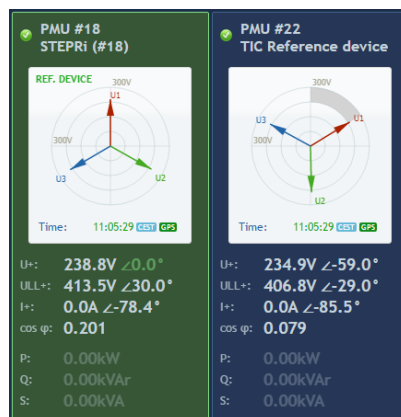

Figure 6.11: Device selected as the reference device (left), and a different device with relatively rotated synchrophasors (right)

6.4.1 SWITCHING BETWEEN REAL-TIME AND HISTORICAL VIEWS

By default, the Compare page shows real-time relative measurements for currently connected devices. In order to freeze the comparison at a specific moment in time, or view historical measurements, it is necessary to switch from Real-time to Historical view using the buttons at the top of the Compare page:

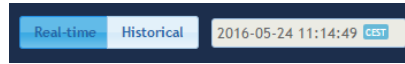

Figure 6.12: To switch from Real-time view to Historical, use the buttons at the top

Once the **Historical view** is selected, the date/time input textbox is enabled for input, and a date/time picker control is shown for easier mouse selection. As the time is modified either using textbox or the sliders below, data is retrieved from the server and displayed in the left and central panels.



Note that Real-time view actually displays measurements with a slightly longer delay (10s). Since communication link between the device and the server can sometimes be slowed down or even disconnected in unreliable GPRS networks, this delay allows the device to connect again and server to retrieve missing frames.

6.5 GEOGRAPHIC LOCATIONS

To view accurate PMU locations on a map, with a possibility to compare measurements, use the **Map** page, accessible from the navigation menu:

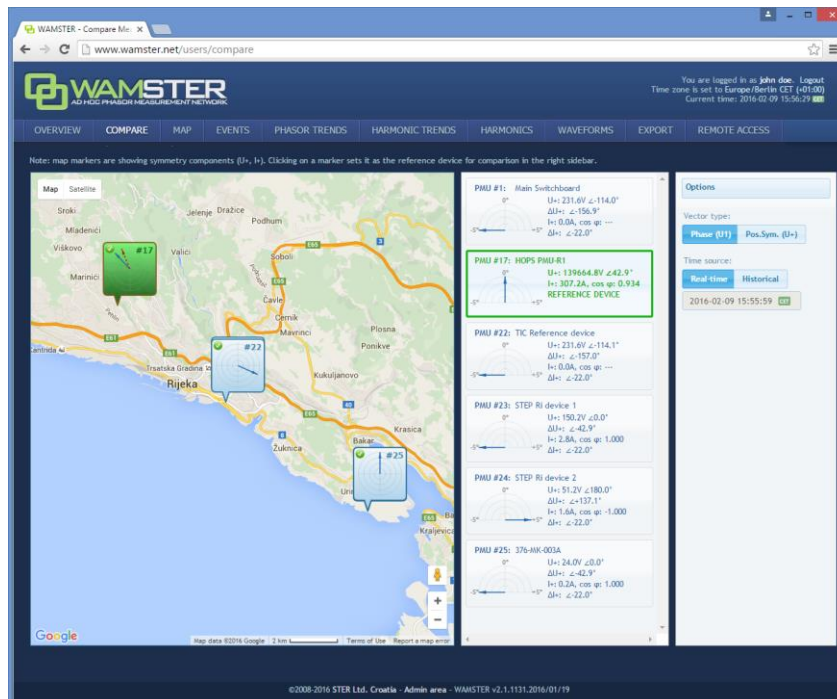

Figure 6.13: Map page allows real-time and historical comparison, with a map showing device locations. Selected reference device is shown in green and can be selected by clicking the entry in the table or on the map.

Left part of the page shows a map with geographical locations of your instruments (as reported by their GPS devices). Each device balloon shows voltage (blue) and current (red) absolute symmetry components, which rotate as the data is received. When a device is clicked, it is marked green and becomes a reference device in the central panel, and other device measurements are displayed relative to the selected device.

Central panel contains a table of devices with actual measurements: absolute current and voltage synchrophasor measurements (positive symmetry components (U+, I+), as well as their relative ($\Delta U+$, $\Delta I+$) angles (compared to the selected reference device marked with green color). Each device entry also displays a visual gauge indicator, showing the relative phasor angle difference (with a fixed range of -5° to +5°).

i Note that if a relative difference is larger than $\pm 5^\circ$, the gauge is not rescaled to keep the same scale as other devices. This means that if the gauge is "floored", it may actually represent a difference outside this range.

6.5.1 SETTING THE REFERENCE DEVICE FOR COMPARISON

By clicking on a specific device balloon on the map, or the same device in the central panel, the device is selected as a **reference device**, which is indicated with a green color, as shown below:

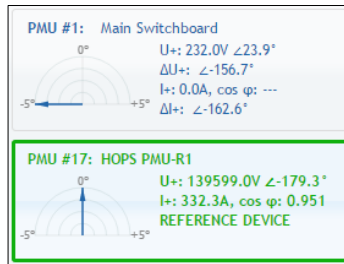

Figure 6.14: Clicking on a device sets it as the reference device, which is indicated with a green border and values shown in green color.

6.5.2 SWITCHING BETWEEN REAL-TIME AND HISTORICAL VIEWS

By default, Map page shows real-time relative measurements for currently connected devices. In order to freeze the comparison at a specific moment in time, it is necessary to switch from Real-time to Historical view using the **right panel** on the Compare page:

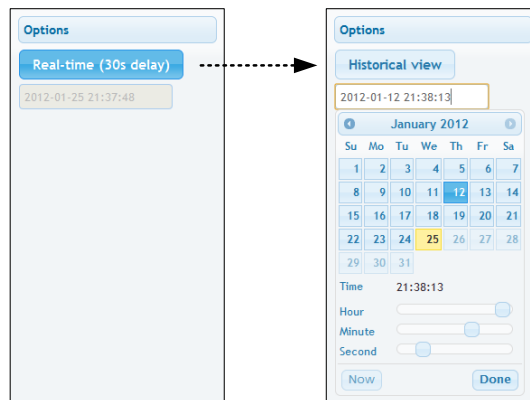

Figure 6.15: Clicking on the Real-time toggle button changes the view to Historical

Once the **Historical view** is selected, the date/time input textbox is enabled for input, and a date/time picker control is shown for easier mouse selection. As the time is modified either using textbox or the sliders below, data is retrieved from the server and displayed in the left and central panels.

i Note that Real-time view actually displays measurements with a slightly longer delay (10s). Since communication link between the device and the server can sometimes be slowed down or even disconnected in unreliable GPRS networks, this delay allows the device to connect again and server to retrieve missing frames.

6.6 CONFIGURING AND VIEWING TRIGGERED EVENTS

Event page shows the list of detected (triggered) events and provides the interface for configuring event triggers for PMU devices.

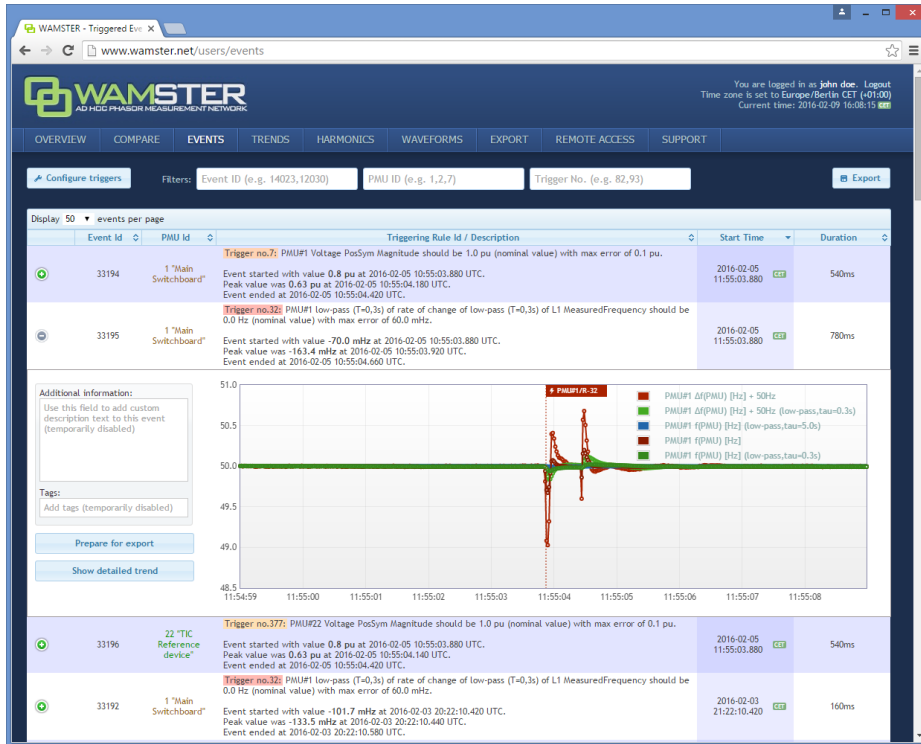

Figure 6.16: List of events. Clicking the green plus-sign button, expands details for the event.

For each entry in the table, user can click the event row (or the green Event details button at the beginning of the row) to show the detailed chart of the quantities which triggered the event. By further clicking on this chart, Trend page will be shown in a separate tab, positioned to the related event, so that the user can further analyze the data and include other channels and devices into the comparison. Trend page allows zooming, panning and various other features as displayed in the following chapter.

Event table can be sorted by different columns by clicking on their column headers, as well as filtered by the event ID, PMU ID, or trigger rule ID. To filter events, use the text boxes above the event table. Each of these text boxes can accept multiple comma separated values.

By clicking the "Configure triggers" link, **Event triggering setup** page is displayed:

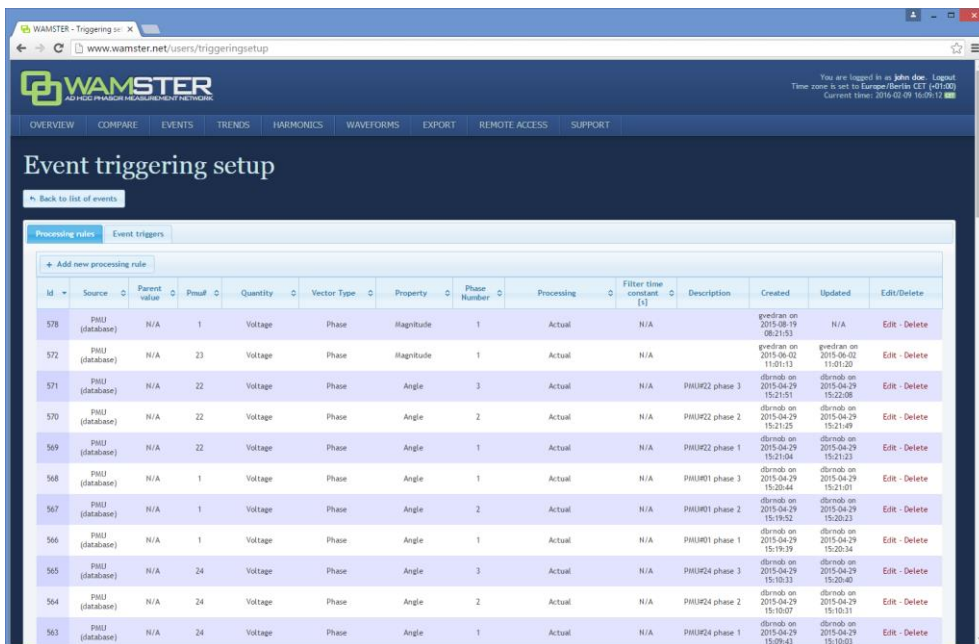

Figure 6.17: Interface for configuring event triggering rules and triggers.

Configuring event triggering consists of two steps:

- **Defining processing rules:** choosing quantities, defining calculations and filters, as well as chaining multiple rules in order to get the processed value for the next step, and
- **Defining event triggers:** choosing a processing rule defined in the first step (or two rules for relative comparison), defining processing rules, hysteresis, preprocessing, and creating thresholds which will trigger the event

Each event trigger can be also be disabled to prevent creating events when the device is not connected or measurements are not yet ready.

6.7 ANALYZING SYNCHROPHASOR TRENDS

Using the **Phasor trends** page, accessible from the top navigation menu, it is possible to quickly view historical trends for all devices, perform measurement comparisons, examine triggered events across multiple devices, and prepare the data for export. If the device functionality supports oscillograms, this page also allows requesting waveforms for certain events of interest.

 When the view is zoomed out for more than 60 seconds, data is displayed using aggregates (minimum, maximum, average for each aggregate interval), with the aggregate interval duration dynamically expanded depending on the zoom level. Each of these intervals (min, avg, max) can be shown or hidden using the toolbar above the chart.

 To speed up data retrieval, aggregates are calculated on 1fps data (0 ms frames only). This can sometimes result in different extremes being shown after zooming in to see the actual phasors. Although such subsecond oscillations are not seen at far zoom-out levels, they can be easily spotted using event annotations placed across the chart.

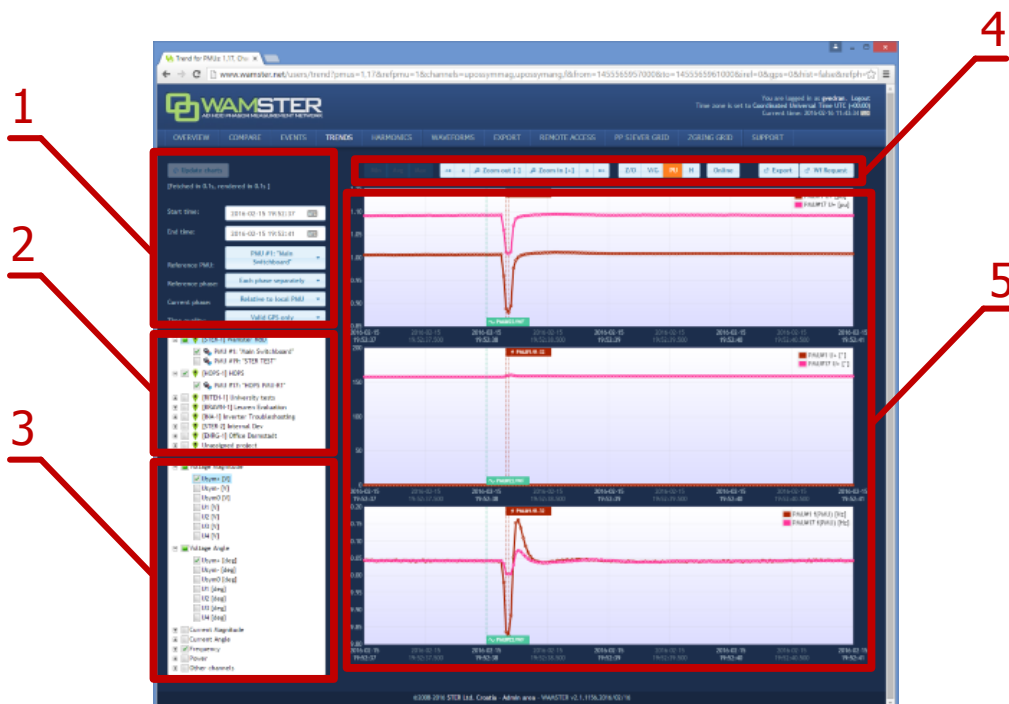

Figure 6.18: Trends page can be used to view and compare measurements during different time periods

Trends page components:

- 1 Data settings sidebar Left settings sidebar contains input boxes for basic chart data settings, and the “Update charts” button which reloads the chart using specified settings.

2	PMU device selection tree	This tree contains all PMU devices registered for the currently logged in user, grouped by their current campaign (project). Checking the device will include its channels in the chart display. By checking the campaign, it is also possible to select multiple devices at once.
3	Channels selection tree	This tree contains a list of all channels. Checking a channel will include data from this channel from all selected PMU devices in the chart.
4	View settings toolbar	Top toolbar contains buttons for adjusting the chart view (toggling individual min/max/average aggregate channels, zooming and panning, setting zero-offsets, toggling histograms), as well as the Online button for enabling the chart to be automatically refreshed every 5 seconds, and buttons for creating export and waveform download requests.
5	Charts	This area shows the charts using the chosen settings, after clicking "Update charts".

6.7.1 DATA SETTINGS SIDEBAR

Left settings sidebar contains tools for defining basic chart settings:

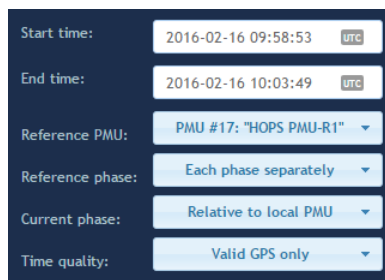

Figure 6.19: Left settings sidebar

After changing any of the settings, the chart is not refreshed until you click the Update charts button.

1	Start time/End time	These textboxes can be used to specify the time range manually. Time is specified in the time zone currently selected in the login status area (top right area of the screen). Moving around the chart can usually be done quicker by selecting an area on the chart using the mouse, or clicking on the chart to center it, or using the zoom/pan toolbar above the chart.
2	Reference PMU	When comparing phasor angles between multiple PMU devices, it is often desirable to display them relative to a single PMU device. This dropdown will show a list of all currently selected PMU devices.
3	Reference phase	If multiple phase channels are selected (e.g. L1 angle and L2 angle) between multiple PMU devices, each phase will be shown on a separate chart. Using this setting, it is possible to set all chart to display angle data relative to a certain phase, or each chart to show separate phase data. If the Reference PMU is not set, then each PMU device will have its own reference phase. If the Reference PMU is set, then all PMUs will use the single phase channel from the reference PMU.
4	Current phase	Current phase channels (current phasor angles) are always displayed relative to their corresponding voltage channels; i.e. I1 angle is always displayed relative to U1 angle. This setting allows you to set make all current angles be shown relative to the reference PMU. If the reference PMU is not selected, this option will be disabled.
5	Time quality	By default, Wamster will only show measurements with fully locked GPS signal. If there are measurements where GPS signal was lost, there will be gaps in the chart at these ranges. Using this setting, it is possible to show all measurements, even those where time was not fully synchronized with the GPS.

6.7.2 VIEW SETTINGS TOOLBAR

View settings toolbar is placed above the chart and contains additional options and actions:



Figure 6.20: Top chart toolbar

1	Min/Avg/Max button group	When the chart is zoomed out and displayed time range is larger than 2 minutes, data is displayed as aggregates (minimum, average and maximum value for each aggregate interval). Individual intervals can be shown or hidden by clicking these buttons.
2	Pan and zoom buttons	Using these buttons, it is possible to zoom in and out of the chart, as well as pan (move) the chart in time. Note that y-axes are always scaled dynamically, depending on the currently displayed signals.
3	Z/O (Zero Offset) button	This button offsets all displayed channels, using the first displayed measurement value as the offset, so that all displayed trends start at the zero y-axis value. This is useful for comparing trends which are mutually offset by a large value. When Z/O is active, chart legend will show the offset value next to each channel. When data samples are hovered with the mouse pointer, channel name will also indicate the offset for the hovered channel.
4	V/G (Vector Group) button	Vector group works similar to the Z/O (zero offset) button, but is applied to angle (phase) channels only and rounds offsets to the nearest transformer vector group (hour-clock number), i.e. an angle multiple of 30°. This is useful when comparing phasor angles from multiple PMU devices from different vector groups.
5	PU (Per Unit) button	When enabled, voltage magnitudes are shown in p.u. (per unit) values (factor of nominal voltage), instead of volts.
6	H (Histogram) button	Toggles the display of histogram charts. If enabled, for each shown time series chart, a histogram is shown, showing the distribution of values displayed in the chart.
7	Online button	Toggles the “Online mode”, where the chart is repeatedly updated to show most recent measurements. While this mode is active, it is still possible to select other settings, devices and channels. Zooming in or out of the chart will turn Online mode off.
8	Export button	Opens the Export page in a new tab, with currently shown devices and time range selected for CSV export.
9	Wf request	Creates a new waveform download request, for the first second shown in the chart, and opens the Waveforms page in a new tab.

6.7.3 CHART INTERACTION

If using a PC to analyze data, parts of the chart can be zoomed in or centered using a mouse:

- To zoom in on a part of the chart, move the mouse over the chart and hold the left mouse button while dragging to select the area. After releasing the button, chart will be refreshed to show the selected area.
- If Ctrl button is held while selecting the area, zoomed chart will be shown on a different tab.
- Clicking on a point on a chart will move the center of the chart to the clicked timestamp.

If using a tablet or a phone to analyze data, chart can be zoomed/panned using the toolbar buttons, or centered by tapping on the chart (similar to left clicking the chart).

6.7.4 CHART ANNOTATIONS

Triggered events and downloaded waveforms are annotated on the chart as colored tags. Event tags are shown at the top of each chart, while waveforms are shown at the bottom. Hovering an event tag shows event information:

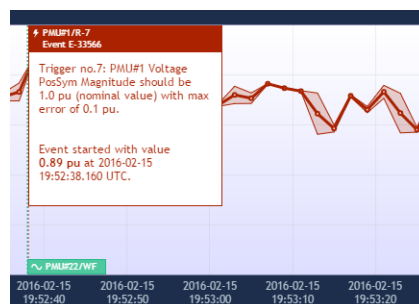

Figure 6.21: Hovered event tag shows event information

Clicking on the waveform tag opens the corresponding waveform in a new tab.

6.8 WAVEFORMS/OSCILLOGRAMS

Waveforms page shows a list downloaded oscillograms, grouped by timestamp in the table view on the left side. Clicking on each entry in the table shows the oscillograms in the right side chart.

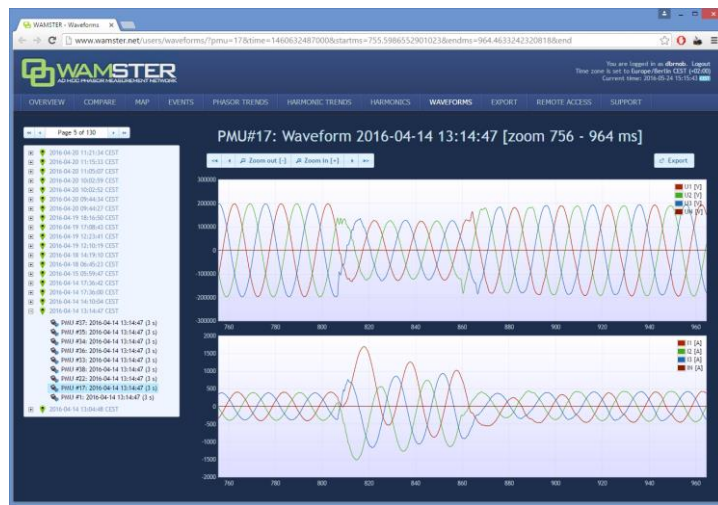

Figure 6.22: Waveforms page

Similar to the trends page, by selecting the area on the oscillogram chart (by clicking and dragging using the mouse), it is possible to zoom in the range. After zooming in, selecting a different device in the same group will show the data for that device, but keep the displayed zoom range, which allows easier comparison of device measurements within a group.

6.9 HARMONICS

Harmonics page shows downloaded voltage and current harmonic aggregates (minimum, average, maximum), for 10-minute aggregate intervals. These measurements are automatically downloaded from each device with the supported firmware version, at the end of each aggregation interval.

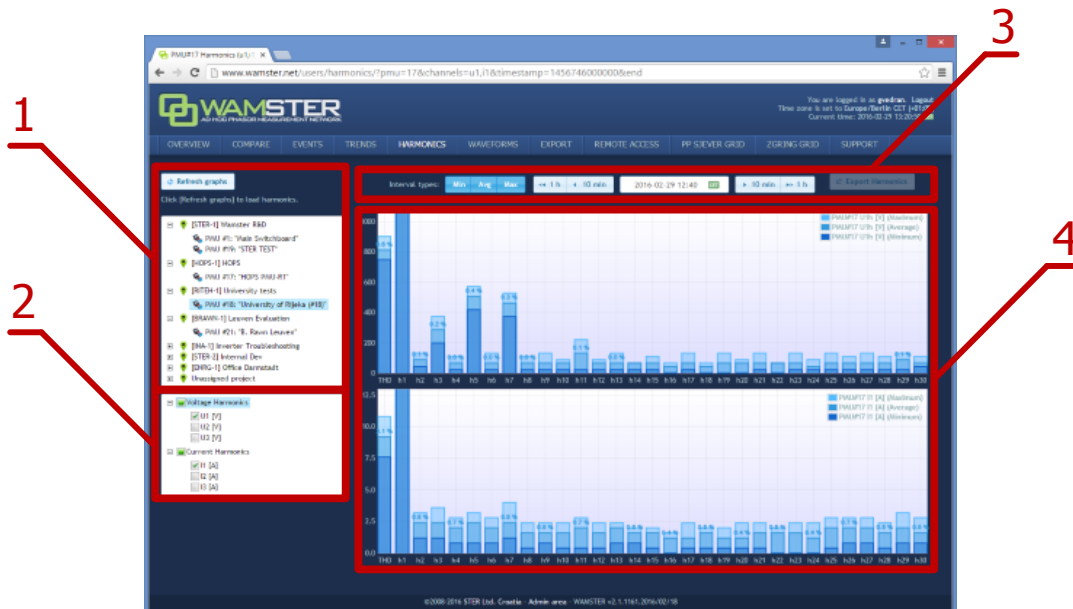

Figure 6.23: Harmonics page provides interaction elements similar to the Trends page

Harmonics page components:

- 1 PMU device selection tree This tree contains all PMU devices registered for the currently logged in user, grouped by their current campaign (project). Selecting a single device will include its harmonic channels in the chart display, after clicking “Refresh graphs”.

- | | | |
|---|-------------------------|--|
| 2 | Channels selection tree | This tree contains a list of voltage and current phases. Checking a channel will include data from this channel in the chart. Some devices might not have all voltage and current channels enabled, depending on their settings. |
| 3 | View settings toolbar | Top toolbar contains buttons for adjusting the chart view (toggling individual min/max/average aggregate channels, setting the timestamp and moving in 10 min. or 1 hour intervals, and exporting the harmonics data. |
| 4 | Charts area | This area displays harmonics using the specified settings, after clicking "Refresh graphs". |

Harmonic bars are shown as percentages of first harmonic (H1). Minimum, average and maximum values in actual units (volts or amperes) can be shown by placing the mouse pointer over each bar in the harmonics chart, which will display a tooltip with additional information.

6.10 HARMONIC TRENDS

Similar to the Phasor trends page, the Harmonic trends shows charts for 10-min. harmonic aggregates. After selecting the time range, one or more PMU devices, and one or more harmonic channels for display, clicking the Update charts button shows the harmonic trend for these parameters:

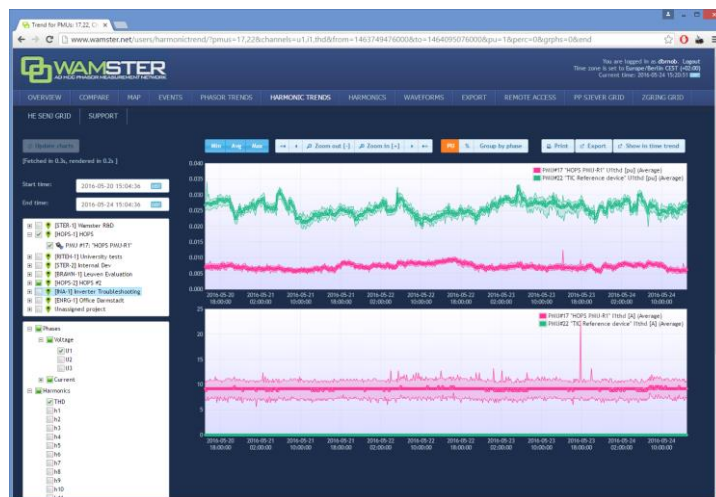

Figure 6.24: Waveforms page

Charts can be panned and zoomed, like explained in chapter 6.7 *Analyzing synchrophasor Trends*.

6.11 EXPORTING AND DOWNLOADING DATA

To export the data from the cloud storage and download it to your computer, select the **Export** page from the navigation menu. On the left side of the page, there is panel for creating new export requests, which allows you to specify the time range for export, export resolution in frames per seconds, and individual devices for which the measurements should be exported.

If the export resolution is higher than the default reporting resolution for a given device, you can also specify whether the server should request these "missing" frames from each device, or not. If your devices are configured to report on a lower speed, and you would like to get a detailed snapshot of a certain time range, you can choose the option to collect those frames.

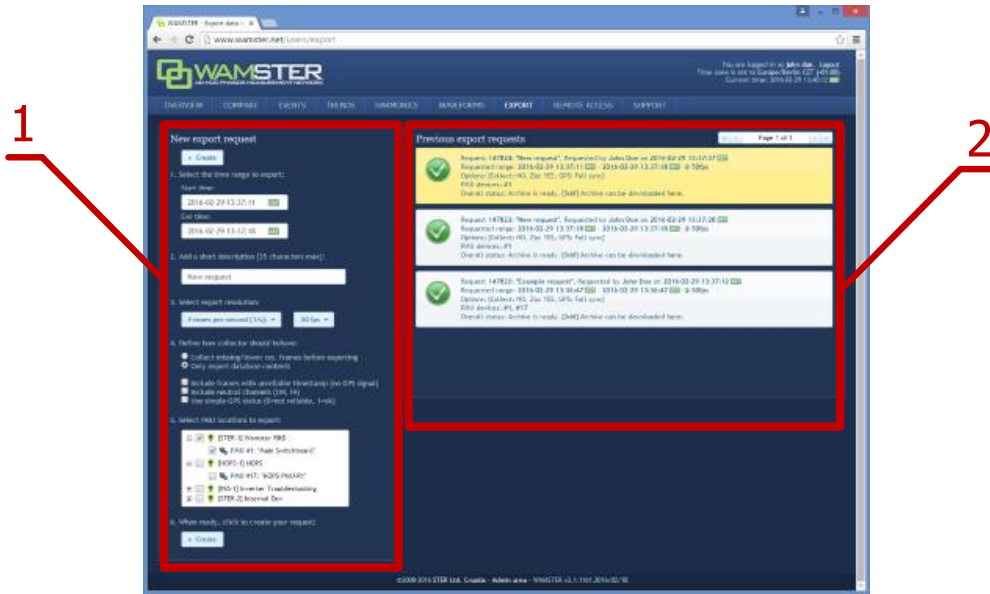

Figure 6.25: Data export page: left panel shows export options, right panel shows previous export requests

Export inputs:

1	Time range	Time range defines inclusive start and end timestamps for the request. Time is specified in the currently selected time zone, but exported timestamps will always be shown as UTC to prevent ambiguity.
2	Short description	Exports can be given a short descriptive name to easily differentiate them.
3	Export resolution (fps)	Export resolution can be specified in fps (frames per second) or by time intervals (seconds between frames).
4	Export settings	Various export settings, described in the following table.
5	PMU devices selection tree	List of PMU devices for the currently signed in user, grouped by project/campaign.
6	“Create” button	Sends the export request to the server.

Export settings:

1	Collect missing/lower res. frames before exporting	If this option is selected, all data which was collected at lower resolution that specified in the export options will be recollected from the device before exporting.
2	Include frames with unreliable timestamp	By default, frames with unreliable time sync are not included in the export. However, since PMUs are equipped with internal clocks, even after losing the GPS signal, quality of the timestamp might still be good enough for the export. Checking this option will include all frames in the export, regardless of the GPS/time source status.
3	Include neutral channels	Checking this option will include U4 and I4 in the export. Leave unchecked if these channels are not physically connected.
4	Use simple GPS status	If checked, GPS column will contain 1 for full time synchronization, and 0 for all other cases (broken cable, unreliable GPS, invalid timestamp, etc). If the “Include frames with unreliable timestamp” option is checked, this option will allow easier differentiation between valid and invalid timestamps. If unchecked, GPS column will contain Wamster-specific GPS flags.



Once the export request is added, it can be canceled, but not modified. If the request is configured to collect all missing frames from the device before exporting, all devices will have to send all requested frames before the export file is completed. Additionally, requests which need to collect more than 15

minutes of data are placed in a lower-priority queue; depending on the mobile network connection type and speed, requests may take significant time to complete.

Since export requests tend to contain large amounts of data, server queues requests and processes them sequentially. Since this may take some time to complete, all requests for a given user (and their current progress statuses) are shown in the right panel on this page. This means that users can queue export requests, log out of the system, and then return later to download the file to their PCs.

Previously finished requests are also available for download, for up to 1 week after creating the request. After 1 week exported files are deleted to conserve server space, but each file can be recreated if needed.

 Data is currently exported in a CSV (comma-separated values) textual format. For information on customization of the format or implementation of other formats, contact support@wamster.net.

6.12 REMOTE ACCESS

For additional configuration options, as well as diagnostics and troubleshooting, Wamster allows each device to be accessed remotely through the **Remote Access** page:

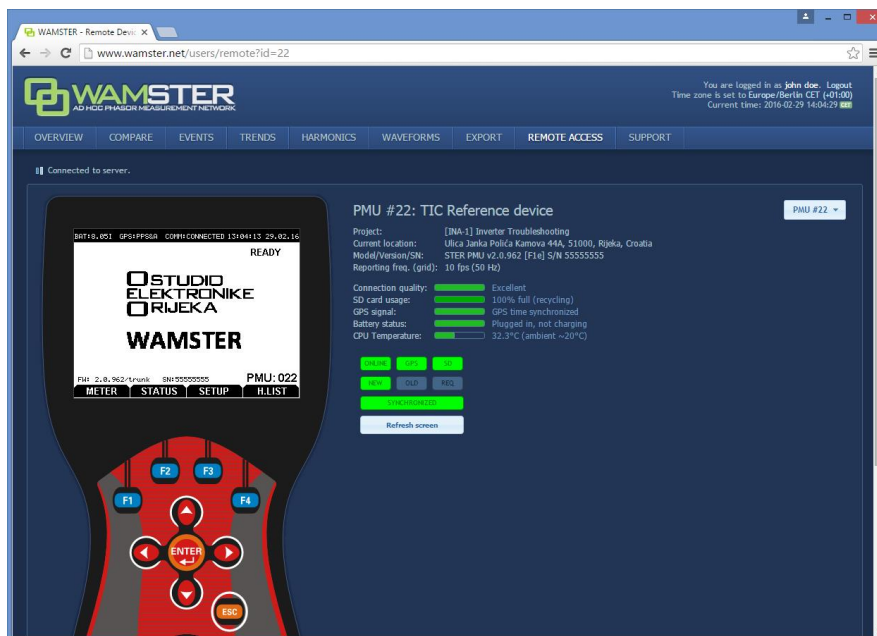

Figure 6.26: Remote access page

Clicking on individual keys on the instrument mask sends these commands to the instrument, while the instrument sends its current screen back to your browser. To prevent a large number of missing frames whenever the screen is changed on slower (GPRS) networks, screen refresh can be only initiated **manually**, by clicking the **Refresh screen** button.

For this reason, when a different screen is selected on the instrument and it differs from the currently displayed image in the browser, status indicator above the Refresh screen button changes from **Synchronized** to **Not synchronized**:



Figure 6.27: If the remote instrument is in a different menu than the one shown on the web page, remote status will change to "NOT SYNCHRONIZED"



Note that "SYNCHRONIZED" status does not necessarily mean that remote instrument screen is showing exactly the same contents as the web page, it only indicates that the same submenu is selected as currently shown. Remote access functionality allows access to the device for extraordinary cases, without drastically impairing the instrument's primary functionality.

6.13 SUPPORT PAGE

Being an online application, Wamster allows download of documents applicable to devices associated with your username. Latest version of each manual is available on the **Support** page, accessible through the navigation menu.

